

Notes Unless Otherwise Specified:

ID	Note
1	ALL WIRES TO BE TERMINATED WITH FERRULES OR CRIMP TERMINALS
2	ALL WIRES 18AWG IF NOT INDICATED
3	SEE WIRING SCHEMATIC FOR JUMPER BAR PLACEMENT ON CIRCUIT BREAKERS AND RELAYS. IGNORE JUMPER BAR INDICATOR ON GROUND TERMINALS
4	ALL WIRE COLORS PER NFPA 79
5	UNTERMINATED WIRES TO BE ISOLATED WITH HEAT SHRINK

Table of Contents

Number	Title
1	Overview
2	Single Line
3	Power
4	Encoders
5	Servo Valves
6	Other IO
7	Gripper
8	Network
9	Enclosure Layout
10	PLC Layout
11	Terminal Layouts
12	Terminal Layouts
13	Bill of Materials
14	Bill of Materials
15	Component List
16	Component List
17	Component List

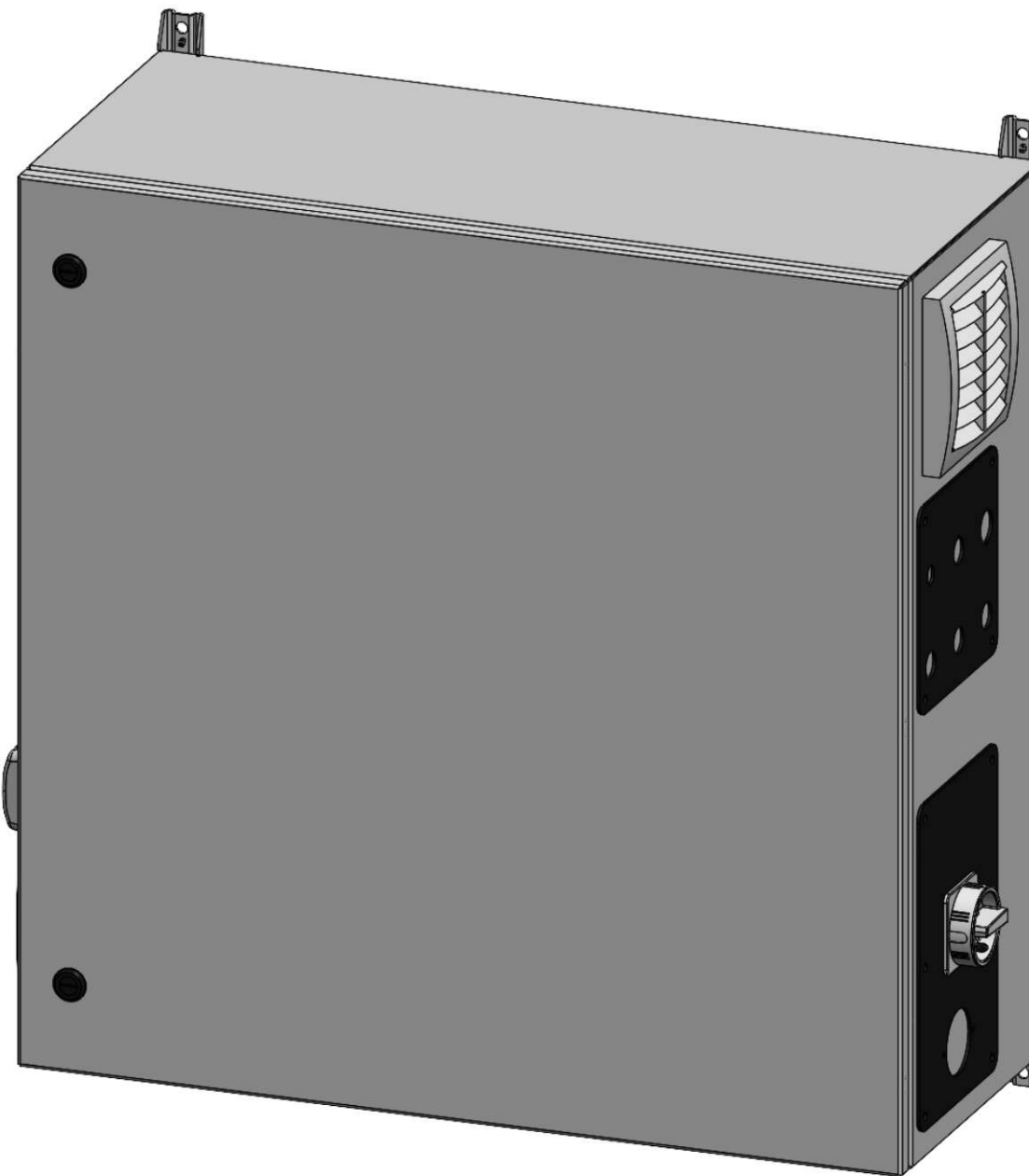

Rev.	Date	Description	Appd. by	Status
A	3/5/2025	Initial Release	A. BURKS	Closed

<b>Project:</b> NRL 66-5 Upgrade
<b>Drawing ID:</b> NRL-000001-DWG
<b>Sheet Title:</b> Overview

<b>Designer:</b> A. Burks
<b>Reviewer:</b> J. Sheehan
<b>Sheet #</b> 1 of 17

0200  
0201  
0202  
0203  
0204  
0205  
0206  
0207  
0208  
0209  
0210  
0211  
0212  
0213  
0214  
0215  
0216  
0217  
0218  
0219  
0220  
0221  
0222  
0223  
0224  
0225  
0226  
0227  
0228  
0229  
0230  
0231  
0232  
0233  
0234  
0235  
0236  
0237  
0238  
0239  
0240  
0241  
0242  
0243  
0244

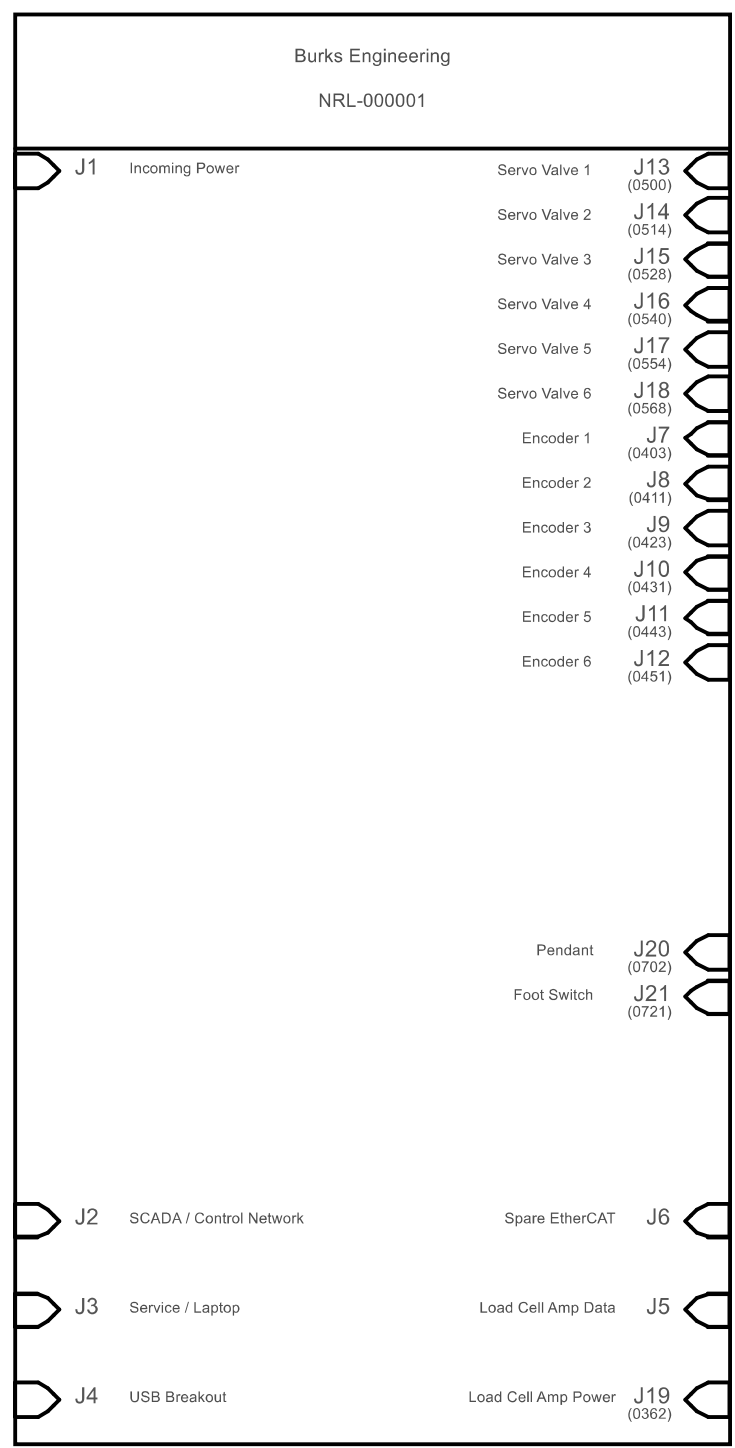

PLATFORM  
NRL  
NRL-66.5  
(1 / 1)

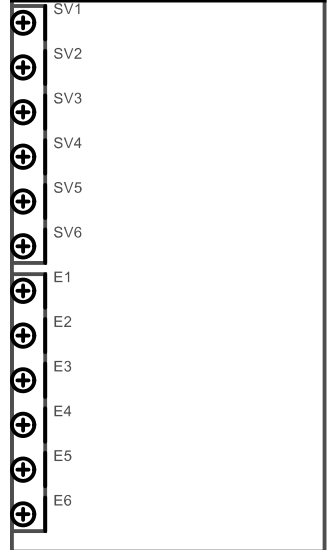

GRIPPER  
Instron  
2718-550  
(1 / 1)

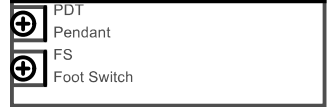

LCAMP  
Interface  
BX8-HD44-EC  
(1 / 1)

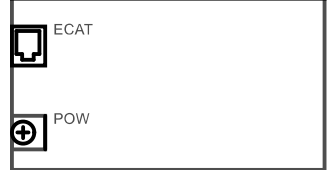

Rev.	Date	Description	Appd. by	Status
A	3/5/2025	Initial Release	A. BURKS	Closed

<b>Project:</b> NRL 66-5 Upgrade	<b>Designer:</b> A. Burks
<b>Drawing ID:</b> NRL-000001-DWG	<b>Reviewer:</b> J. Sheehan
<b>Sheet Title:</b> Single Line	<b>Sheet #</b> 2 of 17

**BURKS**  
ENGINEERING  
info@burksengineering.com



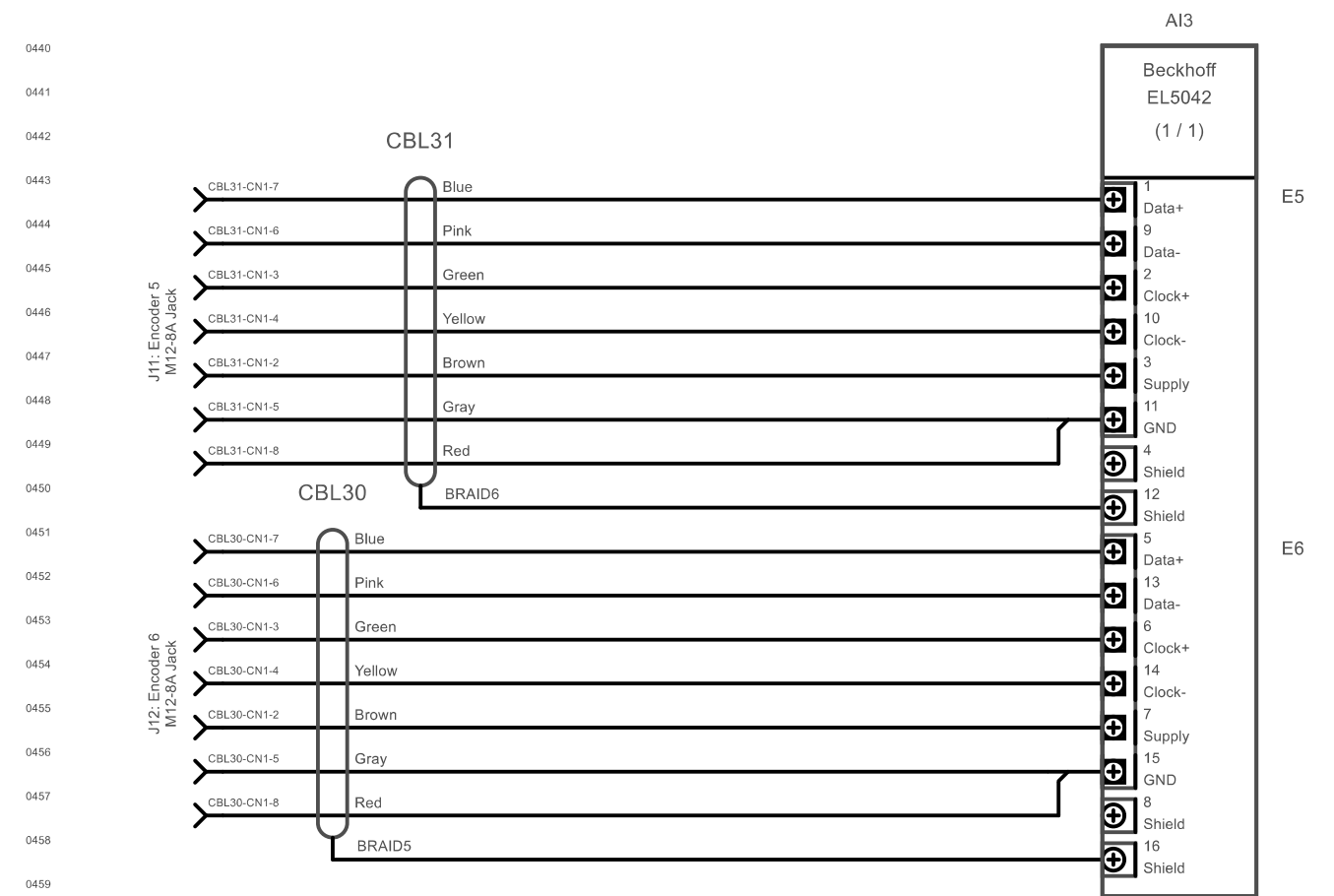
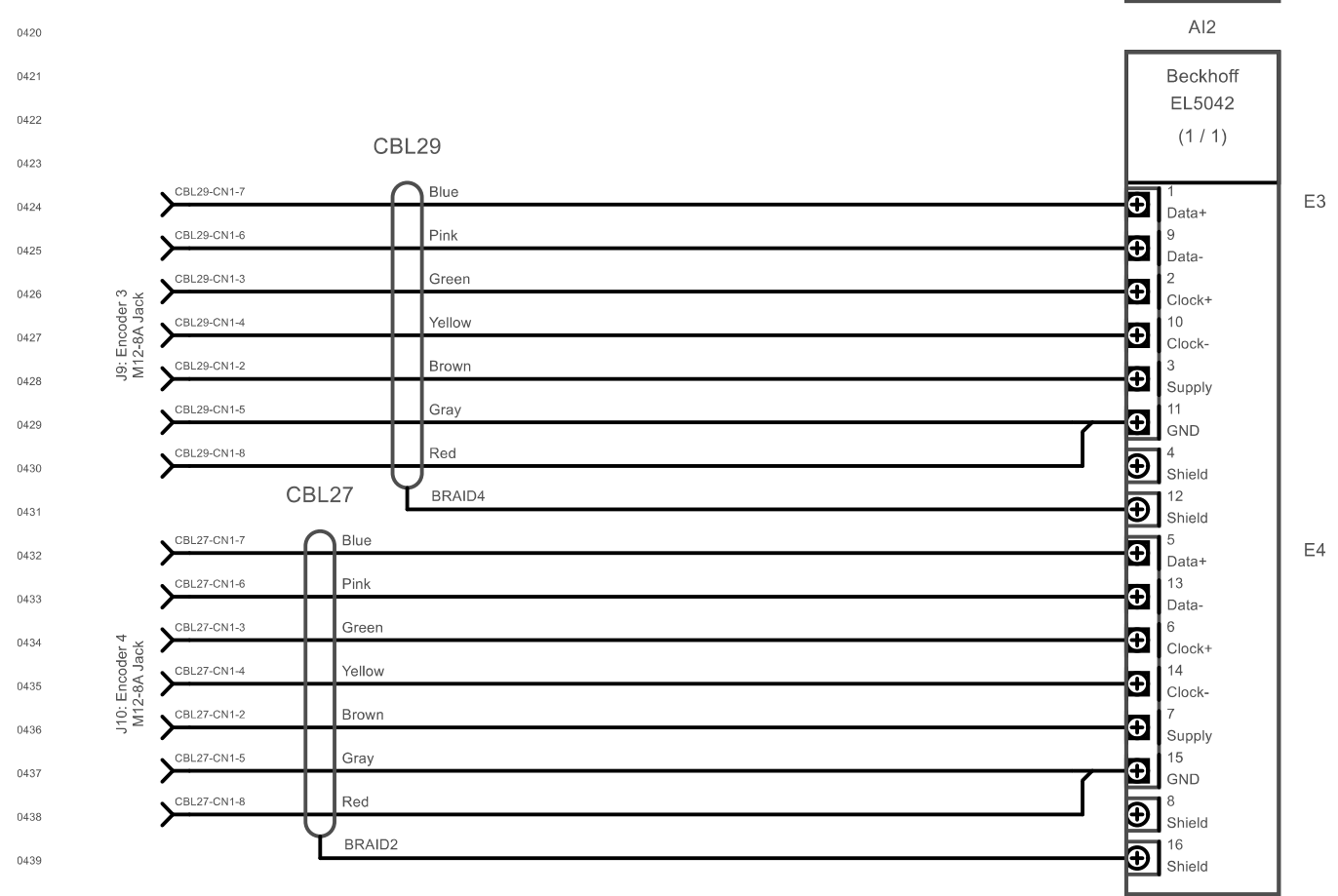
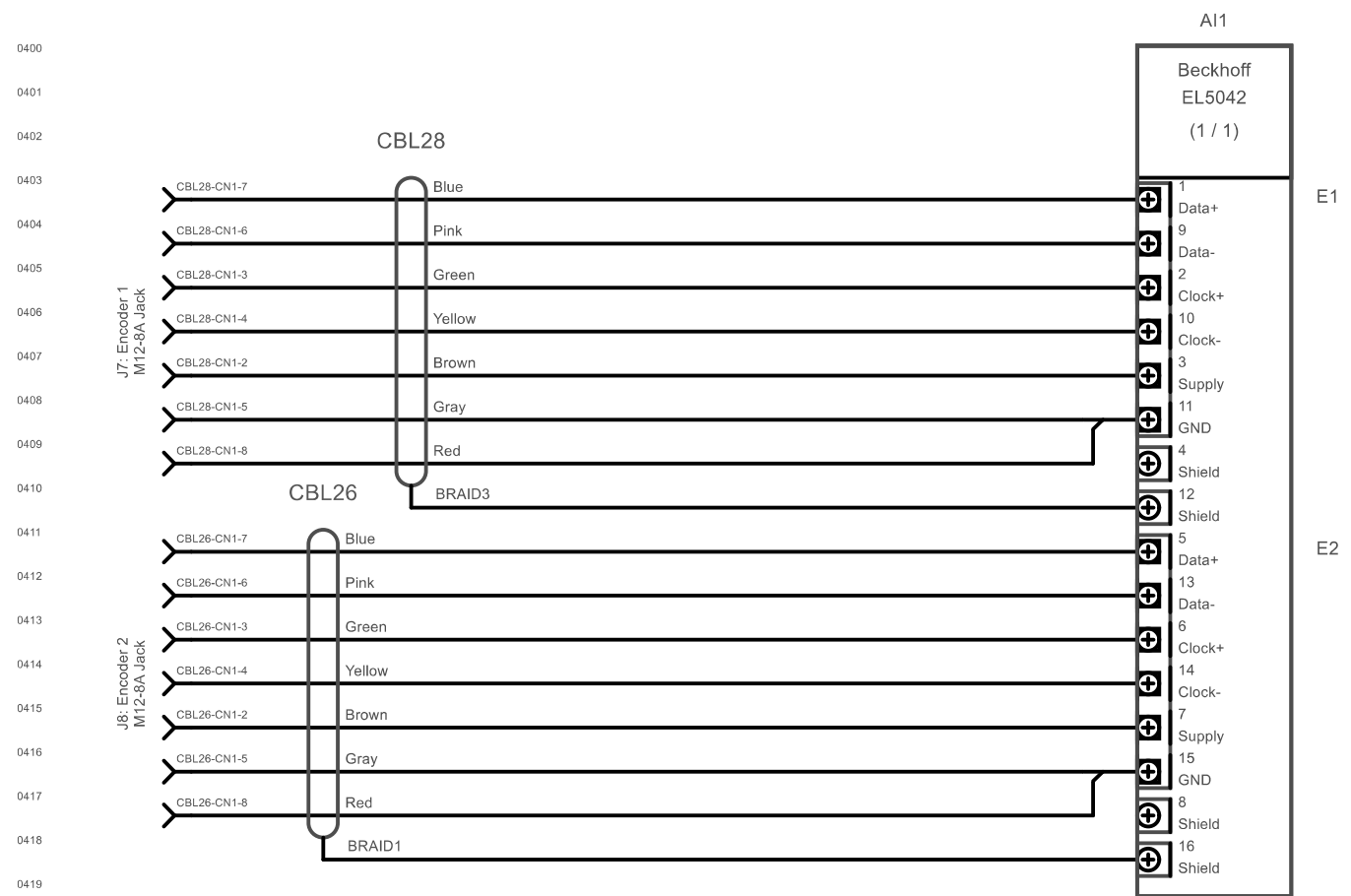

Rev.	Date	Description	Appd. by	Status
A	3/5/2025	Initial Release	A. BURKS	Closed

<b>Project:</b>	NRL 66-5 Upgrade
<b>Drawing ID:</b>	NRL-000001-DWG
<b>Sheet Title:</b>	Encoders

<b>Designer:</b>	A. Burks
<b>Reviewer:</b>	J. Sheehan
<b>Sheet #</b>	4 of 17

# BURKS ENGINEERING

info@burksengineering.com

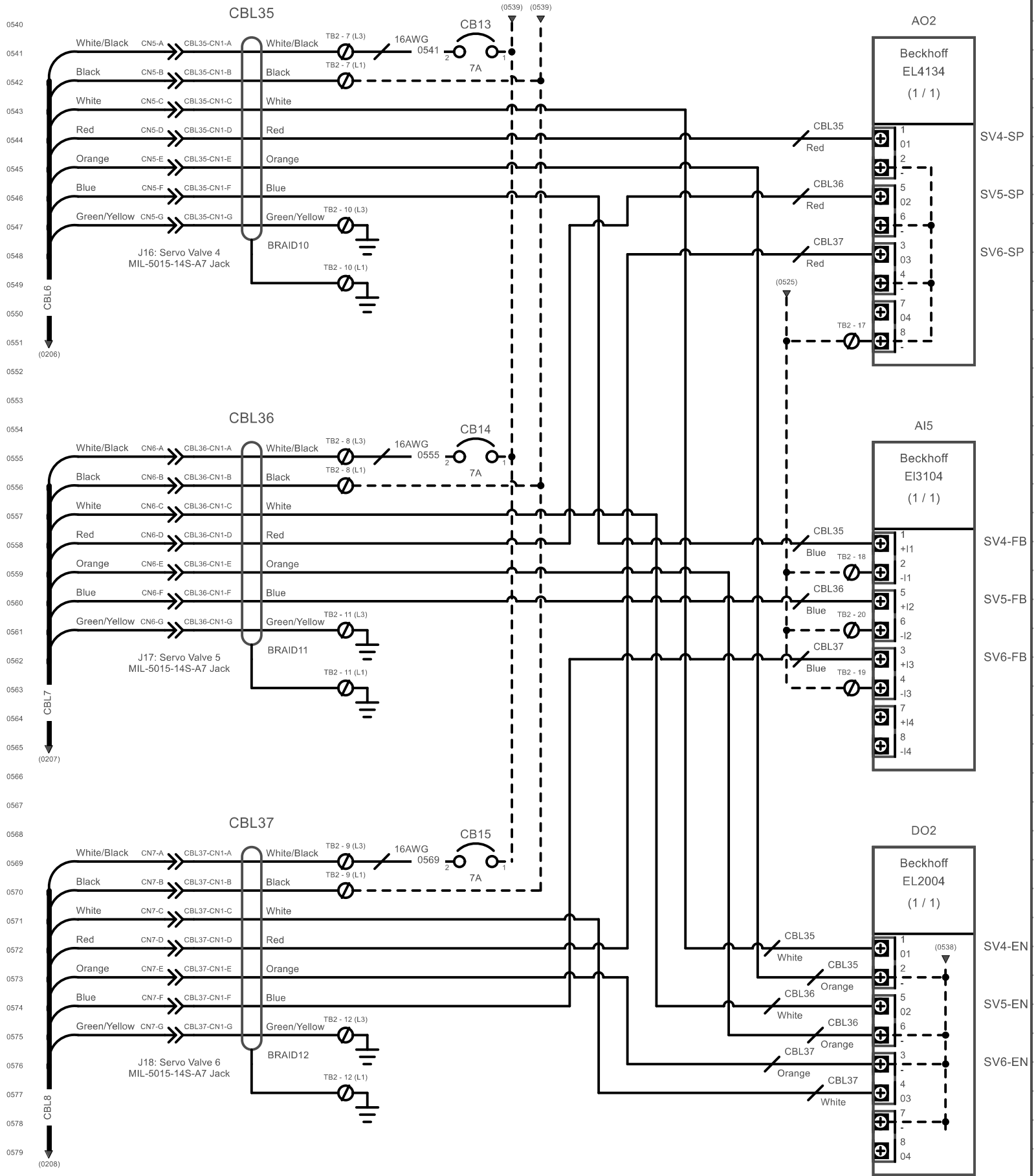
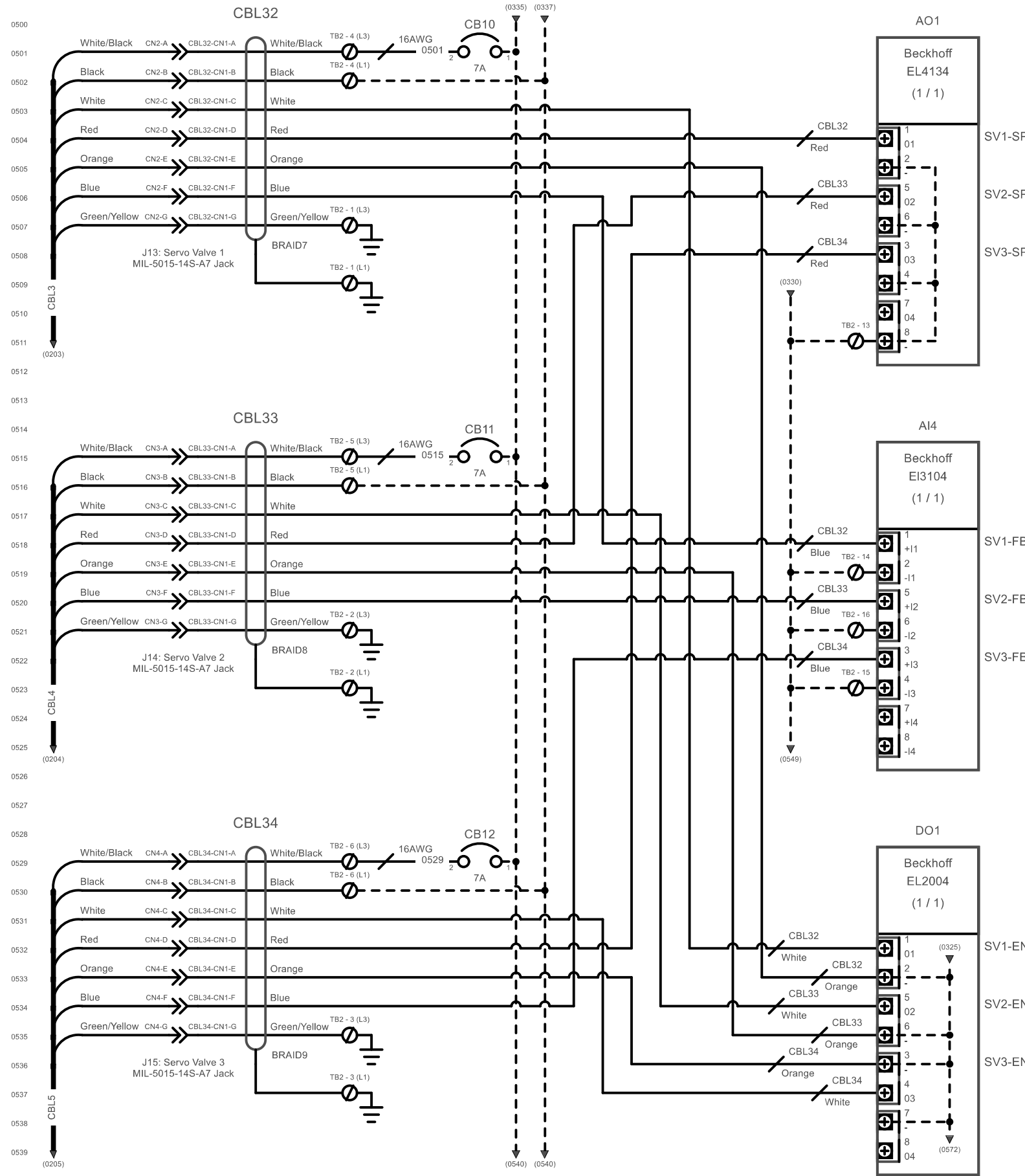

Rev.	Date	Description	Appd. by	Status
A	3/5/2025	Initial Release	A. BURKS	Closed

**Project:**  
 NRL 66-5 Upgrade  
**Drawing ID:**  
 NRL-000001-DWG  
**Sheet Title:**  
 Servo Valves

**Designer:**  
 A. Burks  
**Reviewer:**  
 J. Sheehan  
**Sheet #**  
 5 of 17



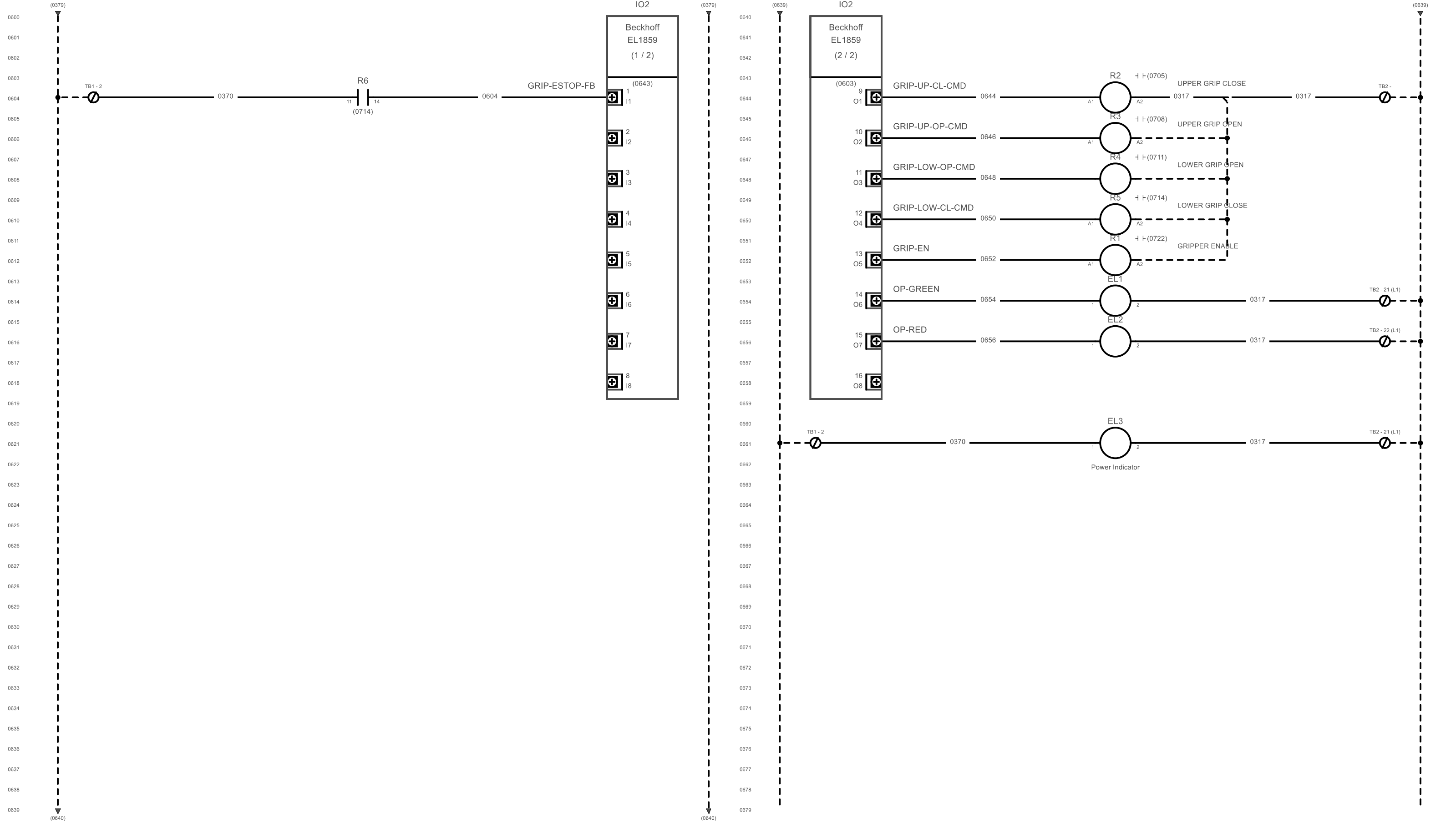

Rev.	Date	Description	Appd. by	Status
A	3/5/2025	Initial Release	A. BURKS	Closed

<b>Project:</b>	NRL 66-5 Upgrade
<b>Drawing ID:</b>	NRL-000001-DWG
<b>Sheet Title:</b>	Other IO

<b>Designer:</b>	A. Burks
<b>Reviewer:</b>	J. Sheehan
<b>Sheet #</b>	6 of 17

**BURKS**  
ENGINEERING

info@burksengineering.com

0700  
0701  
0702  
0703  
0704  
0705  
0706  
0707  
0708  
0709  
0710  
0711  
0712  
0713  
0714  
0715  
0716  
0717  
0718  
0719  
0720  
0721  
0722  
0723  
0724  
0725  
0726  
0727  
0728  
0729  
0730  
0731  
0732  
0733  
0734  
0735  
0736  
0737  
0738  
0739

0740  
0741  
0742  
0743  
0744  
0745  
0746  
0747  
0748  
0749  
0750  
0751  
0752  
0753  
0754  
0755  
0756  
0757  
0758  
0759  
0760  
0761  
0762  
0763  
0764  
0765  
0766  
0767  
0768  
0769  
0770  
0771  
0772  
0773  
0774  
0775  
0776  
0777  
0778  
0779

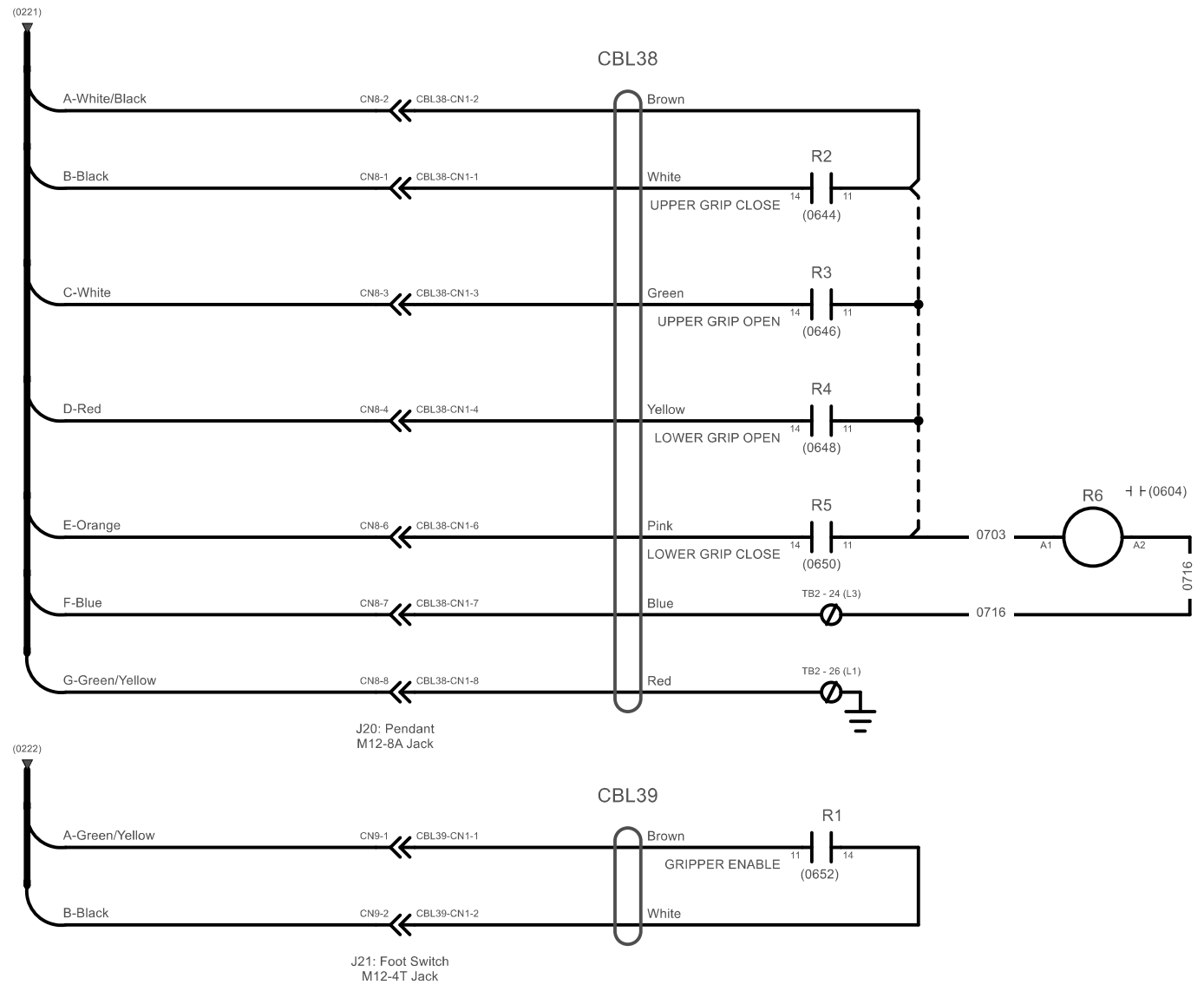

Rev.	Date	Description	Appd. by	Status
A	3/5/2025	Initial Release	A. BURKS	Closed

<b>Project:</b>	NRL 66-5 Upgrade	<b>Designer:</b>	A. Burks
<b>Drawing ID:</b>	NRL-000001-DWG	<b>Reviewer:</b>	J. Sheehan
<b>Sheet Title:</b>	Gripper	<b>Sheet #</b>	7 of 17

**BURKS**  
ENGINEERING  
info@burksengineering.com

0800  
0801  
0802  
0803  
0804  
0805  
0806  
0807  
0808  
0809  
0810  
0811  
0812  
0813  
0814  
0815  
0816  
0817  
0818  
0819  
0820  
0821  
0822  
0823  
0824  
0825  
0826  
0827  
0828  
0829  
0830  
0831  
0832  
0833  
0834  
0835  
0836  
0837  
0838  
0839

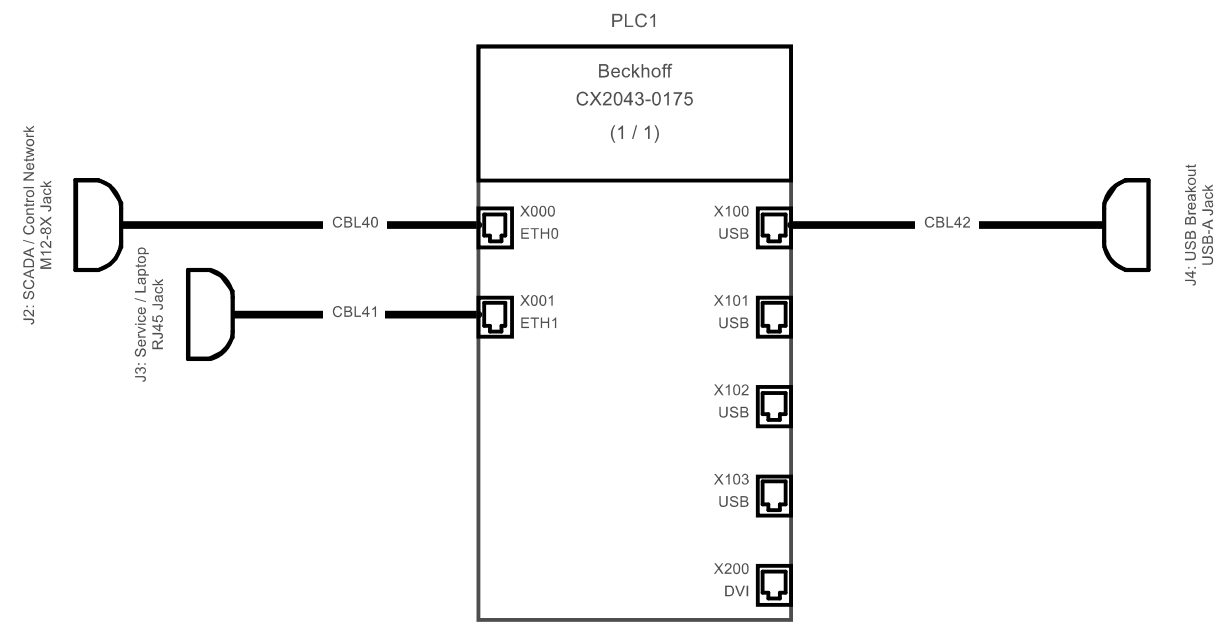

0840  
0841  
0842  
0843  
0844  
0845  
0846  
0847  
0848  
0849  
0850  
0851  
0852  
0853  
0854  
0855  
0856  
0857  
0858  
0859  
0860  
0861  
0862  
0863  
0864  
0865  
0866  
0867  
0868  
0869  
0870  
0871  
0872  
0873  
0874  
0875  
0876  
0877  
0878  
0879

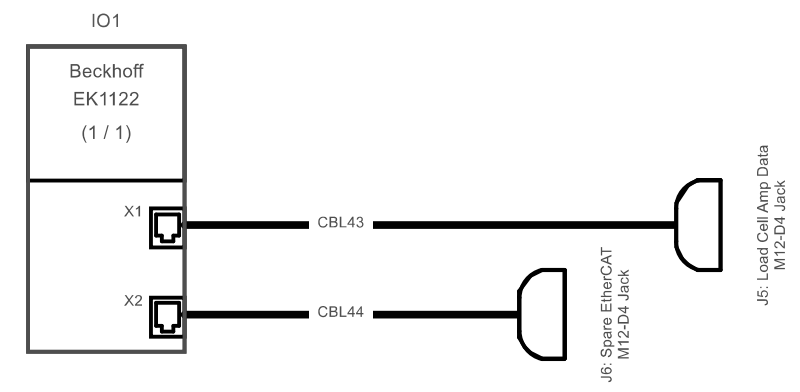

Rev.	Date	Description	Appd. by	Status
A	3/5/2025	Initial Release	A. BURKS	Closed

<b>Project:</b>	NRL 66-5 Upgrade
<b>Drawing ID:</b>	NRL-000001-DWG
<b>Sheet Title:</b>	Network

<b>Designer:</b>	A. Burks
<b>Reviewer:</b>	J. Sheehan
<b>Sheet #</b>	8 of 17

**BURKS**  
ENGINEERING  
info@burksengineering.com

ENC-LEFT

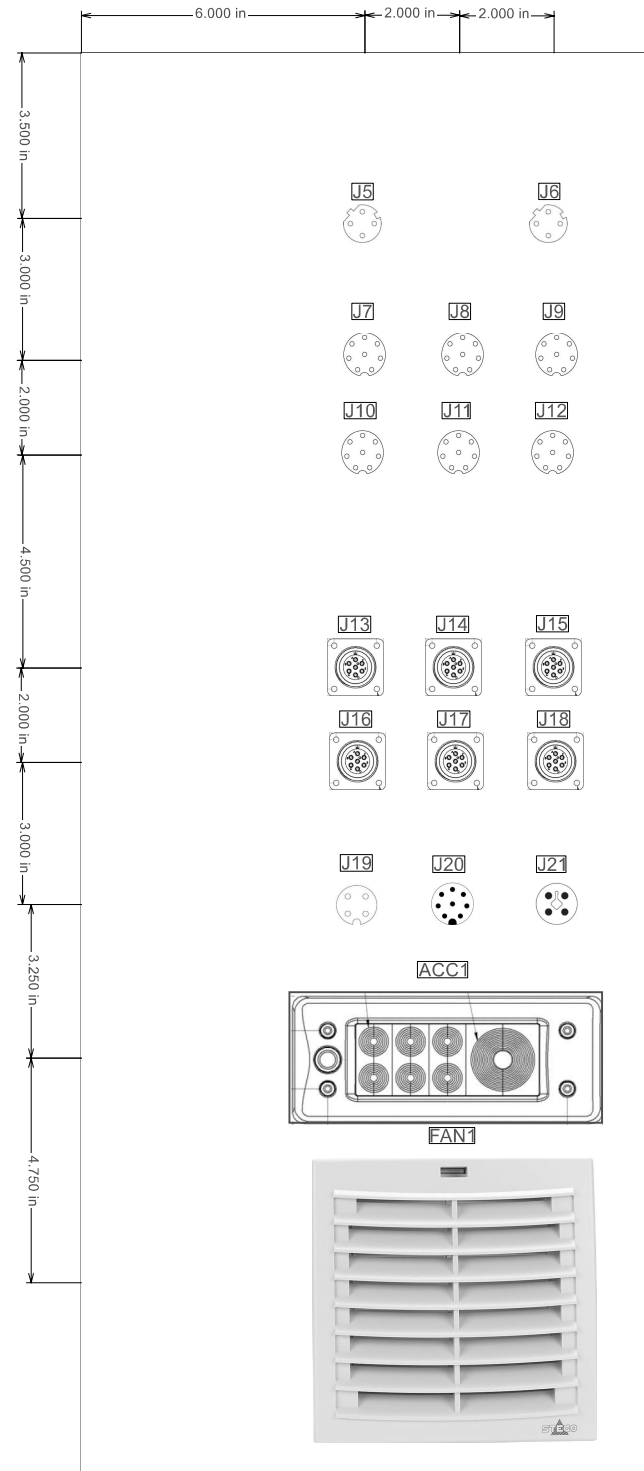

ENC-BP

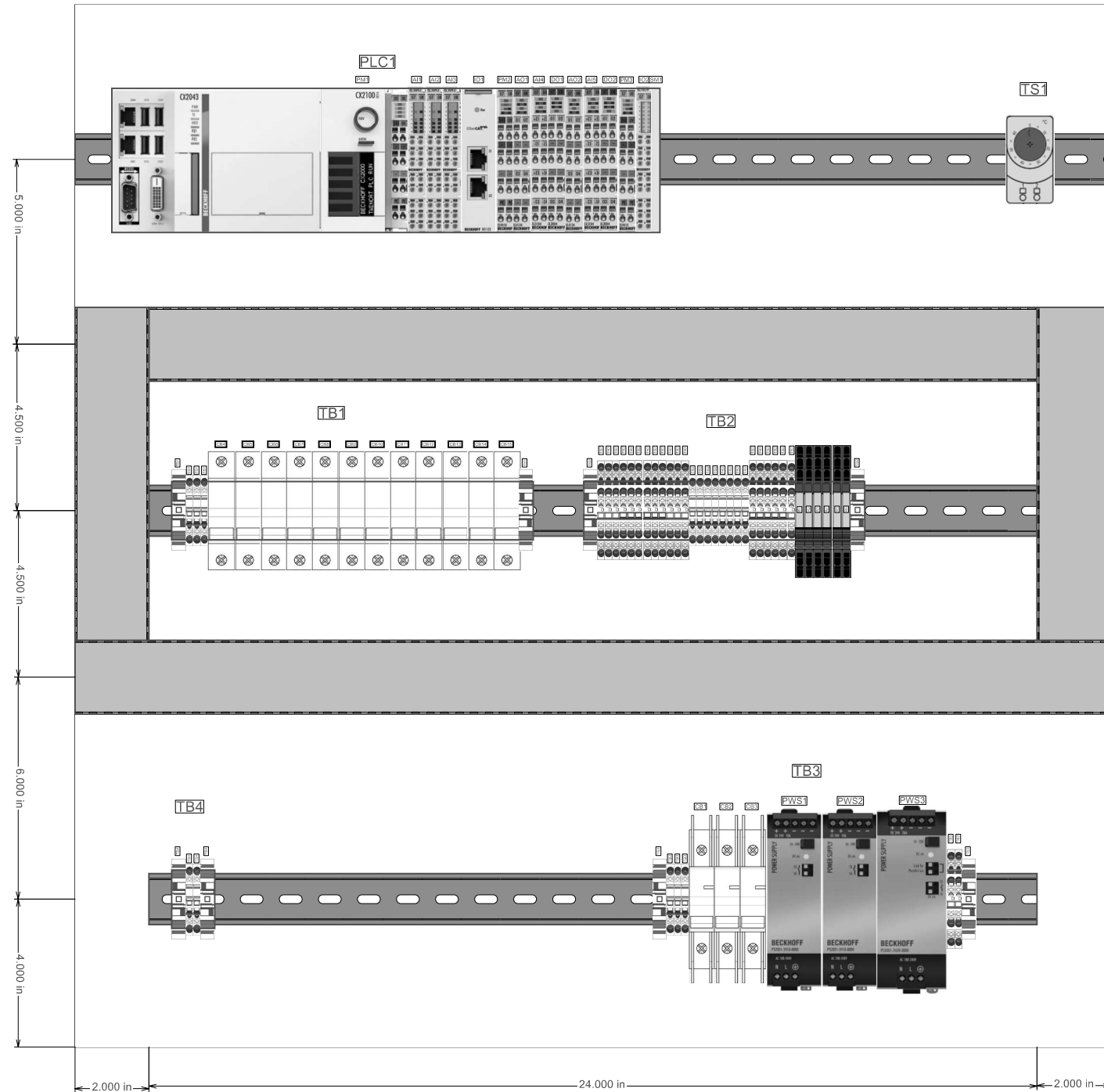

ENC-RIGHT

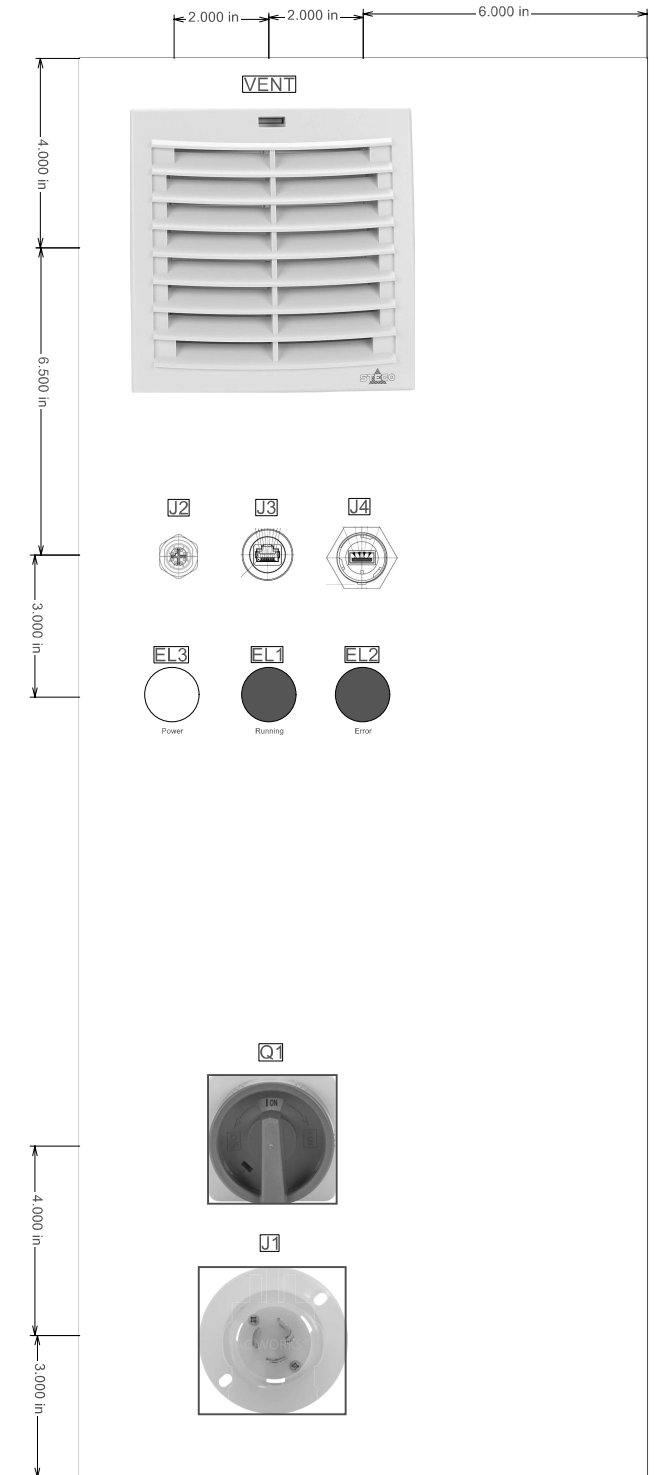

Rev.	Date	Description	Appd. by	Status
A	3/5/2025	Initial Release	A. BURKS	Closed

<b>Project:</b>	NRL 66-5 Upgrade
<b>Drawing ID:</b>	NRL-000001-DWG
<b>Sheet Title:</b>	Enclosure Layout

<b>Designer:</b>	A. Burks
<b>Reviewer:</b>	J. Sheehan
<b>Sheet #</b>	9 of 17



# PLC1

PM1      AI1   AI2   AI3      IO1      PM2   AO1   AI4   DO1   AO2   AI5   DO2   PM3   IO2 SM1

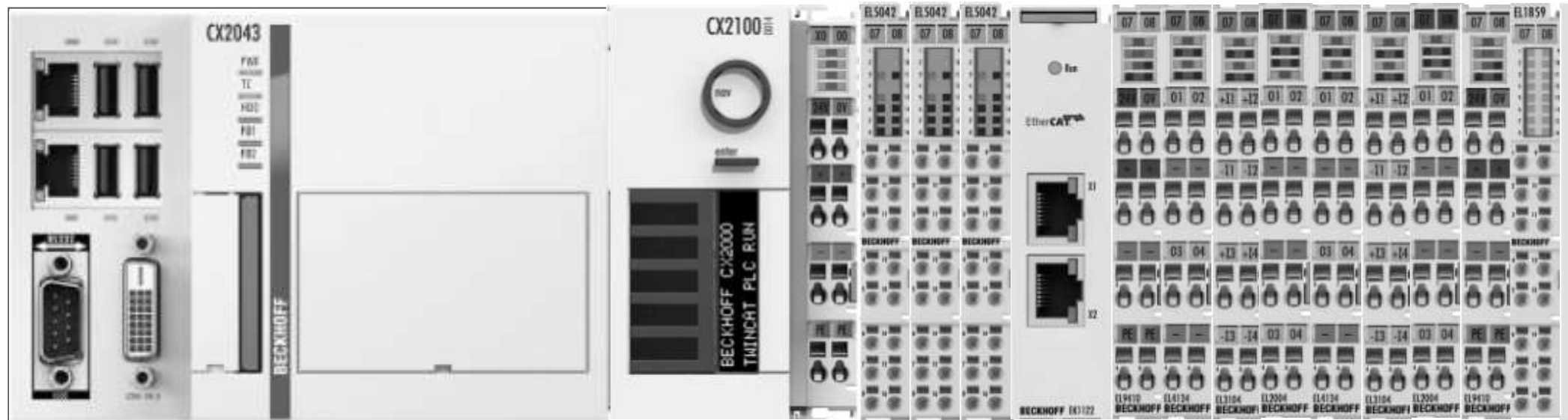

Rev.	Date	Description	Appd. by	Status
A	3/5/2025	Initial Release	A. BURKS	Closed

<b>Project:</b> NRL 66-5 Upgrade	<b>Designer:</b> A. Burks
<b>Drawing ID:</b> NRL-000001-DWG	<b>Reviewer:</b> J. Sheehan
<b>Sheet Title:</b> PLC Layout	<b>Sheet #</b> 10 of 17

**BURKS**  
ENGINEERING  
info@burksengineering.com

### ENC-BP-TB1 (Single level view)

Component	Class name	Description	Part number	Manufacturer	Current range
ENC-BP-TB1-End stop	End stop	ClipFix End Stop	3022218	Phoenix Contact	
ENC-BP-TB1-1	Terminal	2 Point Terminal Block, Push-in, PT 2.5, 26-12AWG	3209510	Phoenix Contact	
ENC-BP-TB1-2	Terminal	2 Point Terminal Block, Push-in, PT 2.5, 26-12AWG	3209510	Phoenix Contact	
ENC-BP-TB1-3	Terminal	2 Point Terminal Block, Push-in, PT 2.5, 26-12AWG	3209510	Phoenix Contact	
ENC-BP-TB1-CB4	Circuit Breaker	Miniature Circuit Breaker TMC-71C-4A	1019975	Phoenix Contact	4A
ENC-BP-TB1-CB5	Circuit Breaker	Miniature Circuit Breaker TMC-71C-4A	1019975	Phoenix Contact	4A
ENC-BP-TB1-CB6	Circuit Breaker	Miniature Circuit Breaker TMC-71C-7A	1019978	Phoenix Contact	7A
ENC-BP-TB1-CB7	Circuit Breaker	Miniature Circuit Breaker TMC-71C-7A	1019978	Phoenix Contact	7A
ENC-BP-TB1-CB8	Circuit Breaker	Miniature Circuit Breaker TMC-71C-4A	1019975	Phoenix Contact	4A
ENC-BP-TB1-CB9	Circuit Breaker	Miniature Circuit Breaker TMC-71C-3A	1019974	Phoenix Contact	3A
ENC-BP-TB1-CB10	Circuit Breaker	Miniature Circuit Breaker TMC-71C-7A	1019978	Phoenix Contact	7A
ENC-BP-TB1-CB11	Circuit Breaker	Miniature Circuit Breaker TMC-71C-7A	1019978	Phoenix Contact	7A
ENC-BP-TB1-CB12	Circuit Breaker	Miniature Circuit Breaker TMC-71C-7A	1019978	Phoenix Contact	7A
ENC-BP-TB1-CB13	Circuit Breaker	Miniature Circuit Breaker TMC-71C-7A	1019978	Phoenix Contact	7A
ENC-BP-TB1-CB14	Circuit Breaker	Miniature Circuit Breaker TMC-71C-7A	1019978	Phoenix Contact	7A
ENC-BP-TB1-CB15	Circuit Breaker	Miniature Circuit Breaker TMC-71C-7A	1019978	Phoenix Contact	7A
ENC-BP-TB1-End stop	End stop	ClipFix End Stop	3022218	Phoenix Contact	

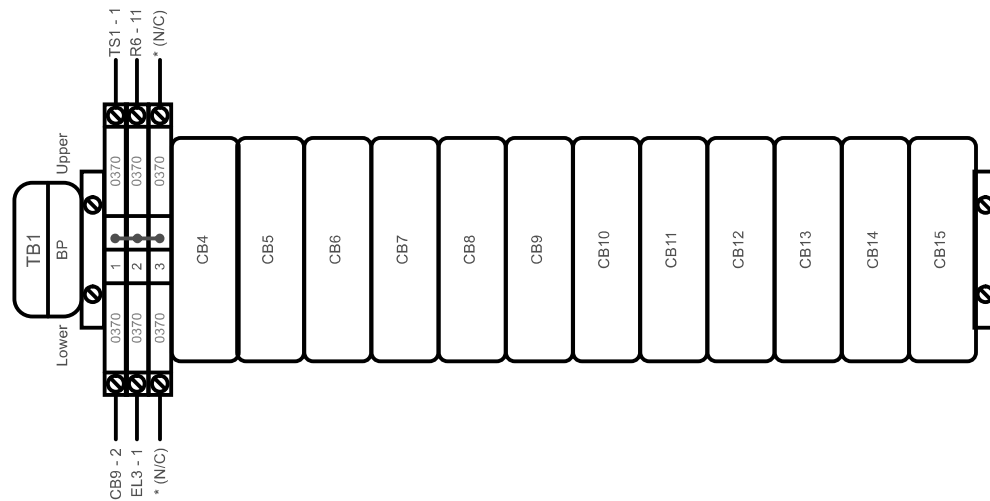

### ENC-BP-TB2 (Single level view)

Component	Class name	Description	Part number	Manufacturer
ENC-BP-TB2-End stop	End stop	ClipFix End Stop	3022218	Phoenix Contact
ENC-BP-TB2-1 (Stacked)	Terminal	4 Point Ground Terminal, Push-in, PTTB 2.5	3210596	Phoenix Contact
ENC-BP-TB2-2 (Stacked)	Terminal	4 Point Ground Terminal, Push-in, PTTB 2.5	3210596	Phoenix Contact
ENC-BP-TB2-3 (Stacked)	Terminal	4 Point Ground Terminal, Push-in, PTTB 2.5	3210596	Phoenix Contact
ENC-BP-TB2-4 (Stacked)	Terminal	Double level terminal, Push-in, PTTB 2.5, 26-12 AWG	3210567	Phoenix Contact
ENC-BP-TB2-5 (Stacked)	Terminal	Double level terminal, Push-in, PTTB 2.5, 26-12 AWG	3210567	Phoenix Contact
ENC-BP-TB2-6 (Stacked)	Terminal	Double level terminal, Push-in, PTTB 2.5, 26-12 AWG	3210567	Phoenix Contact
ENC-BP-TB2-7 (Stacked)	Terminal	Double level terminal, Push-in, PTTB 2.5, 26-12 AWG	3210567	Phoenix Contact
ENC-BP-TB2-8 (Stacked)	Terminal	Double level terminal, Push-in, PTTB 2.5, 26-12 AWG	3210567	Phoenix Contact
ENC-BP-TB2-9 (Stacked)	Terminal	Double level terminal, Push-in, PTTB 2.5, 26-12 AWG	3210567	Phoenix Contact
ENC-BP-TB2-10 (Stacked)	Terminal	4 Point Ground Terminal, Push-in, PTTB 2.5	3210596	Phoenix Contact
ENC-BP-TB2-11 (Stacked)	Terminal	4 Point Ground Terminal, Push-in, PTTB 2.5	3210596	Phoenix Contact
ENC-BP-TB2-12 (Stacked)	Terminal	4 Point Ground Terminal, Push-in, PTTB 2.5	3210596	Phoenix Contact
ENC-BP-TB2-13	Terminal	2 Point Terminal Block, Push-in, PT 2.5, 26-12AWG	3209510	Phoenix Contact
ENC-BP-TB2-14	Terminal	2 Point Terminal Block, Push-in, PT 2.5, 26-12AWG	3209510	Phoenix Contact
ENC-BP-TB2-15	Terminal	2 Point Terminal Block, Push-in, PT 2.5, 26-12AWG	3209510	Phoenix Contact
ENC-BP-TB2-16	Terminal	2 Point Terminal Block, Push-in, PT 2.5, 26-12AWG	3209510	Phoenix Contact
ENC-BP-TB2-17	Terminal	2 Point Terminal Block, Push-in, PT 2.5, 26-12AWG	3209510	Phoenix Contact
ENC-BP-TB2-18	Terminal	2 Point Terminal Block, Push-in, PT 2.5, 26-12AWG	3209510	Phoenix Contact
ENC-BP-TB2-19	Terminal	2 Point Terminal Block, Push-in, PT 2.5, 26-12AWG	3209510	Phoenix Contact
ENC-BP-TB2-20	Terminal	2 Point Terminal Block, Push-in, PT 2.5, 26-12AWG	3209510	Phoenix Contact
ENC-BP-TB2-21 (Stacked)	Terminal	Double level terminal, Push-in, PTTB 2.5, 26-12 AWG	3210567	Phoenix Contact
ENC-BP-TB2-22 (Stacked)	Terminal	Double level terminal, Push-in, PTTB 2.5, 26-12 AWG	3210567	Phoenix Contact
ENC-BP-TB2-23 (Stacked)	Terminal	Double level terminal, Push-in, PTTB 2.5, 26-12 AWG	3210567	Phoenix Contact
ENC-BP-TB2-24 (Stacked)	Terminal	Double level terminal, Push-in, PTTB 2.5, 26-12 AWG	3210567	Phoenix Contact
ENC-BP-TB2-25 (Stacked)	Terminal	Double level terminal, Push-in, PTTB 2.5, 26-12 AWG	3210567	Phoenix Contact
ENC-BP-TB2-26 (Stacked)	Terminal	4 Point Ground Terminal, Push-in, PTTB 2.5	3210596	Phoenix Contact
ENC-BP-TB2-R1	Relay	RIF-0-RPT-24DC/21 - Relay module	2903370	Phoenix Contact
ENC-BP-TB2-R2	Relay	RIF-0-RPT-24DC/21 - Relay module	2903370	Phoenix Contact
ENC-BP-TB2-R3	Relay	RIF-0-RPT-24DC/21 - Relay module	2903370	Phoenix Contact
ENC-BP-TB2-R4	Relay	RIF-0-RPT-24DC/21 - Relay module	2903370	Phoenix Contact
ENC-BP-TB2-R5	Relay	RIF-0-RPT-24DC/21 - Relay module	2903370	Phoenix Contact
ENC-BP-TB2-R6	Relay	RIF-0-RPT-24DC/21 - Relay module	2903370	Phoenix Contact
ENC-BP-TB2-End stop	End stop	ClipFix End Stop	3022218	Phoenix Contact

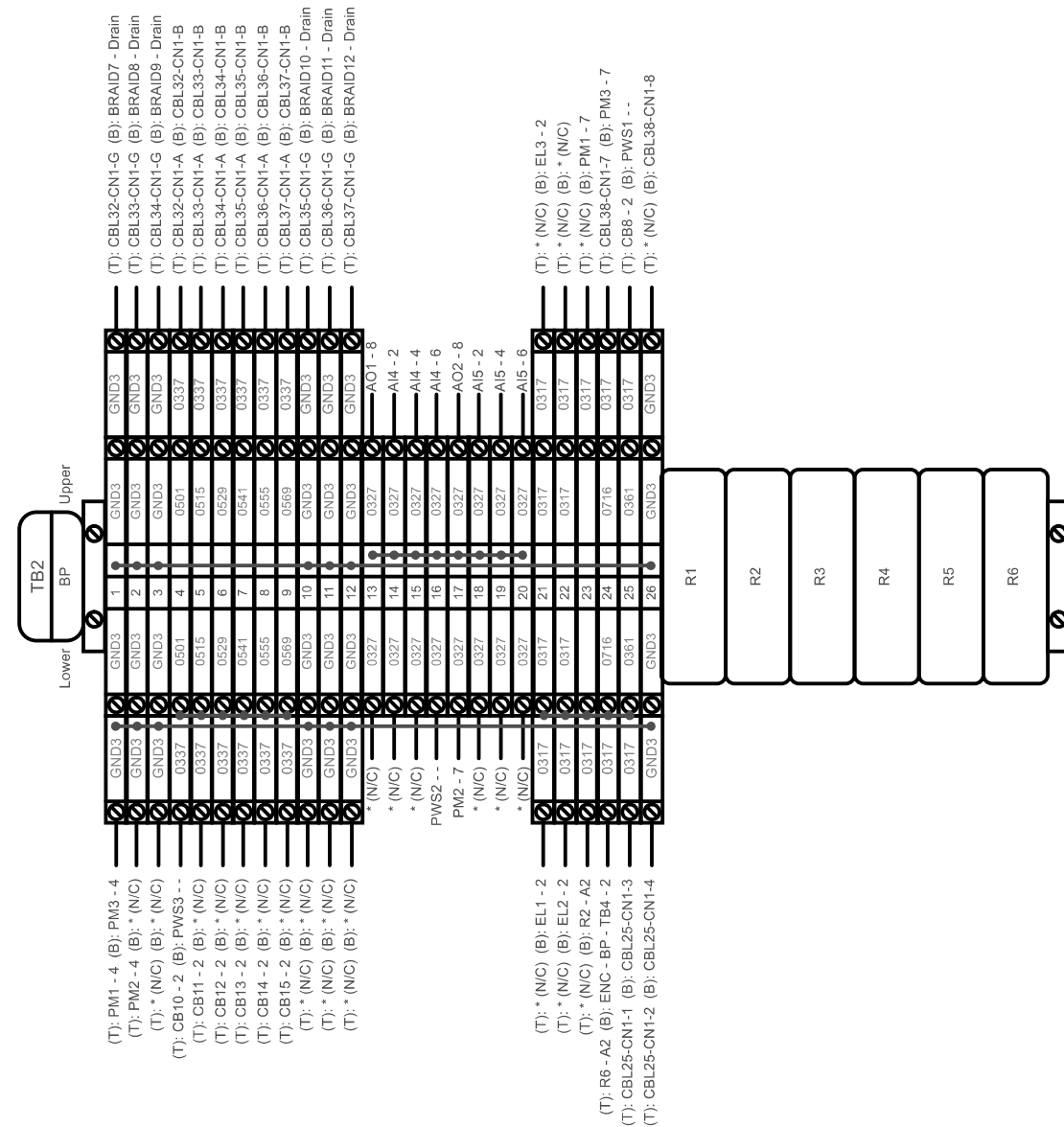

Rev.	Date	Description	Appd. by	Status
A	3/5/2025	Initial Release	A. BURKS	Closed

Project:  
NRL 66-5 Upgrade

Drawing ID:  
NRL-000001-DWG

Sheet Title:  
Terminal Layouts

Designer:  
A. Burks

Reviewer:  
J. Sheehan

Sheet #  
11 of 17

# BURKS ENGINEERING

info@burksengineering.com

### ENC-BP-TB3 (Single level view)

Component	Class name	Description	Part number	Manufacturer	Current range
ENC-BP-TB3-End stop	End stop	ClipFix End Stop	3022218	Phoenix Contact	
ENC-BP-TB3-1	Terminal	2 Point Terminal Block, Push-in, PT 2.5, 26-12AWG	3209510	Phoenix Contact	
ENC-BP-TB3-2	Terminal	2 Point Terminal Block, Push-in, PT 2.5, 26-12AWG	3209510	Phoenix Contact	
ENC-BP-TB3-3	Terminal	2 Point Terminal Block, Push-in, PT 2.5, 26-12AWG	3209510	Phoenix Contact	
ENC-BP-TB3-CB1	Circuit Breaker	Miniature Circuit Breaker TMC-81C-07A	2907564	Phoenix Contact	7A
ENC-BP-TB3-CB2	Circuit Breaker	Miniature Circuit Breaker TMC-81C-12A	2907568	Phoenix Contact	12A
ENC-BP-TB3-CB3	Circuit Breaker	Miniature Circuit Breaker TMC-81C-07A	2907564	Phoenix Contact	7A
ENC-BP-TB3-PWS1	Power supply	output: 24 V DC, 10 A; input: AC 100...240 V/DC 110...150 V, 1-phase	PS2001-2410-0000	Beckhoff	
ENC-BP-TB3-PWS2	Power supply	output: 24 V DC, 10 A; input: AC 100...240 V/DC 110...150 V, 1-phase	PS2001-2410-0000	Beckhoff	
ENC-BP-TB3-PWS3	Power supply	output: 24 V DC, 20 A; input: AC 100...240 V/DC 110...150 V, 1-phase	PS2001-2420-0000	Beckhoff	
ENC-BP-TB3-4 (Stacked)	Terminal	4 Point Ground Terminal, Push-in, PTTB 2.5	3210596	Phoenix Contact	
ENC-BP-TB3-5 (Stacked)	Terminal	4 Point Ground Terminal, Push-in, PTTB 2.5	3210596	Phoenix Contact	
ENC-BP-TB3-End stop	End stop	ClipFix End Stop	3022218	Phoenix Contact	

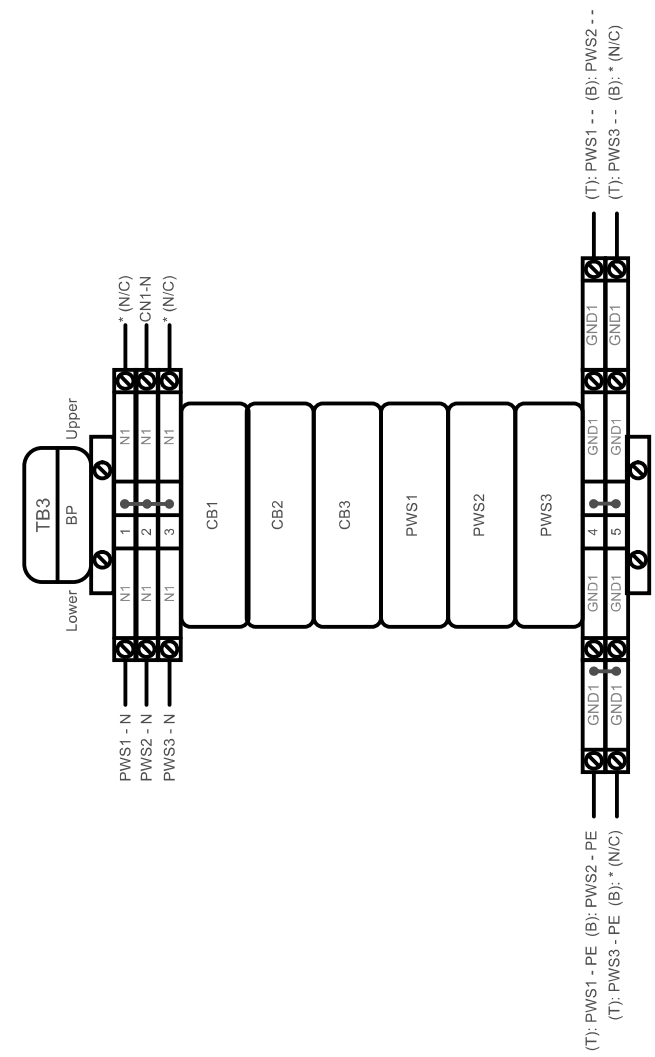

### ENC-BP-TB4 (Single level view)

Component	Class name	Description	Part number	Manufacturer
ENC-BP-TB4-End stop	End stop	ClipFix End Stop	3022218	Phoenix Contact
ENC-BP-TB4-1	Terminal	2 Point Terminal Block, Push-in, PT 2.5, 26-12AWG	3209510	Phoenix Contact
ENC-BP-TB4-2	Terminal	2 Point Terminal Block, Push-in, PT 2.5, 26-12AWG	3209510	Phoenix Contact
ENC-BP-TB4-End stop	End stop	ClipFix End Stop	3022218	Phoenix Contact

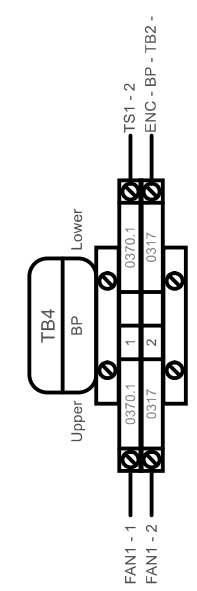

Rev.	Date	Description	Appd. by	Status
A	3/5/2025	Initial Release	A. BURKS	Closed

<b>Project:</b>	NRL 66-5 Upgrade
<b>Drawing ID:</b>	NRL-000001-DWG
<b>Sheet Title:</b>	Terminal Layouts

<b>Designer:</b>	A. Burks
<b>Reviewer:</b>	J. Sheehan
<b>Sheet #</b>	12 of 17

**BURKS**  
ENGINEERING  
info@burksengineering.com

NRL 66-5 Upgrade (BOM)					
Class name	Part number	Manufacturer	Description	Qty	Where used
Connectorized Cable	10-04518	Tensility International	M12-4A Extension Cable	1	CBL18
Wire duct	181-23012	HellermannTyton	White PVC Adhesive+Screw Mount Slotted Wire Duct, 2in Wide x 4in Deep	70.000 in	ENC-BP
Temp. switch	11101.0-00	Stego	KTS-111 0-60C NO Thermostat	1	TS1
Fan	018712-30	Stego	Intake Filter and Fan	1	FAN1
Enclosure accessory	118710-00	Stego	Exhaust Grille	1	ENC-RIGHT-VENT
Connectorized Cable	0847290006	Molex	Panel Mount USB2.0A Extension Cable	1	CBL42
Connectorized Cable	09454521510	Harting	RJ45 to RJ45 (panel mount)	1	CBL41
Circuit Breaker	1019974	Phoenix Contact	Miniature Circuit Breaker TMC-71C-3A	1	ENC-BP-TB1-CB9
Circuit Breaker	1019975	Phoenix Contact	Miniature Circuit Breaker TMC-71C-4A	3	ENC-BP-TB1-CB4 / ENC-BP-TB1-CB5 / ENC-BP-TB1-CB8
Circuit Breaker	1019978	Phoenix Contact	Miniature Circuit Breaker TMC-71C-7A	8	ENC-BP-TB1-CB6 / ENC-BP-TB1-CB7 / ENC-BP-TB1-CB10 / ENC-BP-TB1-CB11 / ENC-BP-TB1-CB12 / ENC-BP-TB1-CB13 / ENC-BP-TB1-CB14 / ENC-BP-TB1-CB15
Terminal block accessory	1022231	Phoenix Contact	Wiring Bridge End Cover	4	0335PDB / 0341PDB
Power Distribution Block	1022233	Phoenix Contact	Bus Bar Terminal Adapter	2	0335PDB / 0341PDB
Terminal block accessory	1022237	Phoenix Contact	Wiring Bridge, 37 Positions, Cut to Length	2	0335PDB / 0341PDB
Connector	1080218	Phoenix Contact	M12-4T Field Wireable Connector, Plug, Female Pins	1	CN9
Connectorized Cable	1203410503	Molex	RJ45 to M12-8X Gigabit Network Cable	1	CBL2
Connectorized Cable	1203410752	Molex	RJ45 to M12-8X (panel mount)	1	CBL40
Connectorized Cable	1204061043	Molex	RJ45 to M12-4D (panel mount)	2	CBL43 / CBL44
Connectorized Cable	1420794	Phoenix Contact	M12-4T Male Plug to wire leads (panel mount)	1	CBL39
Connector	1421680	Phoenix Contact	M12-8A IDC Field Wireable Connector	1	CN8
Connectorized Cable	1446359	Phoenix Contact	M12-4A Recepticle, Femal Pins, Panel Mount, 2m Long	1	CBL25
Connectorized Cable	1446388	Phoenix Contact	M12-8A Male Plug to wire leads (panel mount)	1	CBL38
Connectorized Cable	1446391	Phoenix Contact	M12-8A Female Recepticle to wire leads (panel mount)	6	CBL26 / CBL27 / CBL28 / CBL29 / CBL30 / CBL31
Relay	2903370	Phoenix Contact	RIF-0-RPT-24DC/21 - Relay module	6	ENC-BP-TB2-R1 / ENC-BP-TB2-R2 / ENC-BP-TB2-R3 / ENC-BP-TB2-R4 / ENC-BP-TB2-R5 / ENC-BP-TB2-R6
Circuit Breaker	2907564	Phoenix Contact	Miniature Circuit Breaker TMC-81C-07A	2	ENC-BP-TB3-CB1 / ENC-BP-TB3-CB3
Circuit Breaker	2907568	Phoenix Contact	Miniature Circuit Breaker TMC-81C-12A	1	ENC-BP-TB3-CB2
End stop	3022218	Phoenix Contact	ClipFix End Stop	8	ENC-BP-TB2 / ENC-BP-TB3 / ENC-BP-TB4 / ENC-BP-TB1
Terminal block accessory	3030174	Phoenix Contact	Plug-In bridge, 5.2mm, 3 Position	2	ENC-BP-TB3 / ENC-BP-TB1
Terminal block accessory	3030187	Phoenix Contact	Plug-In Bridge, 5.2mm, 4 Position	1	ENC-BP-TB2-R1
Terminal block accessory	3030213	Phoenix Contact	Plug-In Bridge, 5.2mm, 10 Position (cut to length)	1	ENC-BP-TB2
Terminal block accessory	3030349	Phoenix Contact	Plug-In Bridge, 5.2mm, 5 Position	2	ENC-BP-TB2 / ENC-BP-TB2-R1
Terminal	3209510	Phoenix Contact	2 Point Terminal Block, Push-in, PT 2.5, 26-12AWG	16	ENC-BP-TB2 / ENC-BP-TB3 / ENC-BP-TB4 / ENC-BP-TB1
Terminal	3210567	Phoenix Contact	Double level terminal, Push-in, PTTB 2.5, 26-12 AWG	11	ENC-BP-TB2
Terminal	3210596	Phoenix Contact	4 Point Ground Terminal, Push-in, PTTB 2.5	9	ENC-BP-TB2 / ENC-BP-TB3
Connectorized Cable	AA-0100-RSX	Renishaw	Fortis to M12-8A Encoder Cable	6	CBL19 / CBL20 / CBL21 / CBL22 / CBL23 / CBL24
Connectorized Cable	AB-0300-SSX	Renishaw	M12-8A Extension Cable for Encoder	6	CBL9 / CBL10 / CBL11 / CBL12 / CBL13 / CBL14

Rev.	Date	Description	Appd. by	Status
A	3/5/2025	Initial Release	A. BURKS	Closed

<b>Project:</b>	NRL 66-5 Upgrade	<b>Designer:</b>	A. Burks
<b>Drawing ID:</b>	NRL-000001-DWG	<b>Reviewer:</b>	J. Sheehan
<b>Sheet Title:</b>	Bill of Materials	<b>Sheet #</b>	13 of 17



**BURKS**  
ENGINEERING

info@burksengineering.com

NRL 66-5 Upgrade (BOM)					
Class name	Part number	Manufacturer	Description	Qty	Where used
Connector	ASINL515P	AC Connectors	NEMA L5-15R, Panel Mount	1	CN1
Amplifier	BX8-HD44-EC	Interface	Load Cell Amplifier	1	LCAMP
PLC	CX2043-0175	Beckhoff	Industrial PC	1	PLC1
Power Module	CX2100-0014	Beckhoff	Power supply unit for CX20xx, 130 W	1	PLC1-PM1
PLC Options	CX2900-0038	Beckhoff	CFast Card	1	PLC1
PLC Options	CX2900-0305	Beckhoff	Extension to 16GB Ram	1	PLC1
PLC Module	EK1122	Beckhoff	2-port EtherCAT junction	1	PLC1-IO1
AI Module	EI3104	Beckhoff	4-channel analog input, voltage, ±10 V, 16 bit, differential	2	PLC1-AI4 / PLC1-AI5
PLC Module	EL1859	Beckhoff	8-channel digital input + 8-channel digital output	1	PLC1-IO2
DO Module	EL2004	Beckhoff	4-channel digital output, 24 V DC, 0.5 A	2	PLC1-DO1 / PLC1-DO2
AO Module	EL4134	Beckhoff	4-channel analog output, voltage, ±10 V, 16 bit	2	PLC1-AO1 / PLC1-AO2
AI Module	EL5042	Beckhoff	2-channel encoder interface, BiSS@ C	3	PLC1-AI1 / PLC1-AI2 / PLC1-AI3
System Module	EL9011	Beckhoff	End Cap	1	PLC1-SM1
Power Module	EL9410	Beckhoff	Power supply terminal for E-bus, with diagnostics	2	PLC1-PM2 / PLC1-PM3
Location	EN4SD30312GY	Hammond	Painted Steel Enclosure, 30"x30"x12"	1	ENC
Location	EPG3030	Hammond	Enclosure Back Panel, Galvanized, for 30"x30"	1	ENC-BP
Enclosure accessory	EZ00000001007	Roxtec	Modular Cable Entry Plate, 1x Large, 6x Small	1	ENC-LEFT-ACC1
Enclosure accessory	EZPMFHD	Hammond	Mounting Foot Kit (set of 4)	1	ENC-ACC2
Connectorized Cable	IBX-5501-10	PDUWhips	NEMA L5-15R to NEMA 5-15P Cable	1	CBL1
Cable Braid	MBN0.38SV100	TechFlex	Metal Braid, 3/8" OD	480.000 in	BRAID1 / BRAID2 / BRAID3 / BRAID4 / BRAID5 / BRAID6 / BRAID7 / BRAID8 / BRAID9 / BRAID10 / BRAID11 / BRAID12
Disconnect	ML1-025-E-H03R	Merz	Rotary Disconnect, Front/Side Mount, 3-Pole, 25A	1	Q1
Connectorized Cable	MS14S-7FR-2M-PM	MENCOM	MIL-5015 14S-A7 female recepticle to flying leads (panel mount)	6	CBL32 / CBL33 / CBL34 / CBL35 / CBL36 / CBL37
Connector	MS14S-7MP-FW20-SC	MENCOM	MIL-5015 Connector, 14S-A7, Plug, Pins	6	CN2 / CN3 / CN4 / CN5 / CN6 / CN7
Connectorized Cable	MS14SP-7FPX-5M	MENCOM	MIL-5015 14S-A7 Female Plug to wire leads unshielded cable	6	CBL3 / CBL4 / CBL5 / CBL6 / CBL7 / CBL8
Connectorized Cable	MS16SP-3AMP-5M	MENCOM	MIL-5015 16S-3A, Male Plug to wire leads	1	CBL16
Connectorized Cable	MS16SP-7MPX-5M	MENCOM	MIL-SPEC Size 16S-7, Cordset, 7 Pole, Male Straight, 5M, 18 awg, 8A, Yellow, PUR	1	CBL15
Enclosure accessory	PKT1212	Hammond	Print Pocket, 12" x 12"	1	ENC-ACC1
Power supply	PS2001-2410-0000	Beckhoff	output: 24 V DC, 10 A; input: AC 100...240 V/DC 110...150 V, 1-phase	2	ENC-BP-TB3-PWS1 / ENC-BP-TB3-PWS2
Power supply	PS2001-2420-0000	Beckhoff	output: 24 V DC, 20 A; input: AC 100...240 V/DC 110...150 V, 1-phase	1	ENC-BP-TB3-PWS3
Connectorized Cable	TAD14741111-005	TE Connectivity	M12-4D Patch Cable	1	CBL17
Rail	TS3515SL	American Electrical, INC	DIN Rail, 35mm x 15mm (Extra) Deep, Zinc-Plated Steel	76.000 in	ENC-BP
Enclosure Light	XB5EVB1	Schneider Electric	Power Indicator	1	EL3
Enclosure Light	XB5EVB3	Schneider Electric	Green Light	1	EL1
Enclosure Light	XB5EVB4	Schneider Electric	Red Light	1	EL2

Rev.	Date	Description	Appd. by	Status
A	3/5/2025	Initial Release	A. BURKS	Closed

<b>Project:</b>	NRL 66-5 Upgrade	<b>Designer:</b>	A. Burks
<b>Drawing ID:</b>	NRL-000001-DWG	<b>Reviewer:</b>	J. Sheehan
<b>Sheet Title:</b>	Bill of Materials	<b>Sheet #</b>	14 of 17



**BURKS**  
ENGINEERING

info@burksengineering.com

NRL 66-5 Upgrade (Component List)

Component	Class name	Description	Part number	Manufacturer	Cross Reference	Length	Quantity	Positions
0335PDB	Power Distribution Block	Bus Bar Terminal Adapter	1022233	Phoenix Contact	(0335)		1	
0335PDB-BRIDGE	Terminal block accessory	Wiring Bridge, 37 Positions, Cut to Length	1022237	Phoenix Contact	(0335)		1	6
0335PDB-BRIDGE-CAP	Terminal block accessory	Wiring Bridge End Cover	1022231	Phoenix Contact	(0335)		2	
0341PDB	Power Distribution Block	Bus Bar Terminal Adapter	1022233	Phoenix Contact	(0341)		1	
0341PDB-BRIDGE	Terminal block accessory	Wiring Bridge, 37 Positions, Cut to Length	1022237	Phoenix Contact	(0341)		1	5
0341PDB-BRIDGE-CAP	Terminal block accessory	Wiring Bridge End Cover	1022231	Phoenix Contact	(0341)		2	
BRAID1	Cable Braid	Metal Braid, 3/8" OD	MBN0.38SV100	TechFlex	(0418)	40.000 in	1	
BRAID2	Cable Braid	Metal Braid, 3/8" OD	MBN0.38SV100	TechFlex	(0438)	40.000 in	1	
BRAID3	Cable Braid	Metal Braid, 3/8" OD	MBN0.38SV100	TechFlex	(0410)	40.000 in	1	
BRAID4	Cable Braid	Metal Braid, 3/8" OD	MBN0.38SV100	TechFlex	(0430)	40.000 in	1	
BRAID5	Cable Braid	Metal Braid, 3/8" OD	MBN0.38SV100	TechFlex	(0458)	40.000 in	1	
BRAID6	Cable Braid	Metal Braid, 3/8" OD	MBN0.38SV100	TechFlex	(0450)	40.000 in	1	
BRAID7	Cable Braid	Metal Braid, 3/8" OD	MBN0.38SV100	TechFlex	(0507)	40.000 in	1	
BRAID8	Cable Braid	Metal Braid, 3/8" OD	MBN0.38SV100	TechFlex	(0521)	40.000 in	1	
BRAID9	Cable Braid	Metal Braid, 3/8" OD	MBN0.38SV100	TechFlex	(0535)	40.000 in	1	
BRAID10	Cable Braid	Metal Braid, 3/8" OD	MBN0.38SV100	TechFlex	(0547)	40.000 in	1	
BRAID11	Cable Braid	Metal Braid, 3/8" OD	MBN0.38SV100	TechFlex	(0561)	40.000 in	1	
BRAID12	Cable Braid	Metal Braid, 3/8" OD	MBN0.38SV100	TechFlex	(0575)	40.000 in	1	
CBL1	Connectorized Cable	NEMA L5-15R to NEMA 5-15P Cable	IBX-5501-10	PDUWhips	(0203)	120.000 in	1	
CBL2	Connectorized Cable	RJ45 to M12-8X Gigabit Network Cable	1203410503	Molex	(0227)	120.000 in	1	
CBL3	Connectorized Cable	MIL-5015 14S-A7 Female Plug to wire leads unshielded cable	MS14SP-7FPX-5M	MENCOM	(0203)	200.000 in	1	
CBL4	Connectorized Cable	MIL-5015 14S-A7 Female Plug to wire leads unshielded cable	MS14SP-7FPX-5M	MENCOM	(0204)	200.000 in	1	
CBL5	Connectorized Cable	MIL-5015 14S-A7 Female Plug to wire leads unshielded cable	MS14SP-7FPX-5M	MENCOM	(0205)	200.000 in	1	
CBL6	Connectorized Cable	MIL-5015 14S-A7 Female Plug to wire leads unshielded cable	MS14SP-7FPX-5M	MENCOM	(0206)	200.000 in	1	
CBL7	Connectorized Cable	MIL-5015 14S-A7 Female Plug to wire leads unshielded cable	MS14SP-7FPX-5M	MENCOM	(0207)	200.000 in	1	
CBL8	Connectorized Cable	MIL-5015 14S-A7 Female Plug to wire leads unshielded cable	MS14SP-7FPX-5M	MENCOM	(0208)	200.000 in	1	
CBL9	Connectorized Cable	M12-8A Extension Cable for Encoder	AB-0300-SSX	Renishaw	(0209)	120.000 in	1	
CBL10	Connectorized Cable	M12-8A Extension Cable for Encoder	AB-0300-SSX	Renishaw	(0210)	120.000 in	1	
CBL11	Connectorized Cable	M12-8A Extension Cable for Encoder	AB-0300-SSX	Renishaw	(0211)	120.000 in	1	
CBL12	Connectorized Cable	M12-8A Extension Cable for Encoder	AB-0300-SSX	Renishaw	(0212)	120.000 in	1	
CBL13	Connectorized Cable	M12-8A Extension Cable for Encoder	AB-0300-SSX	Renishaw	(0213)	120.000 in	1	
CBL14	Connectorized Cable	M12-8A Extension Cable for Encoder	AB-0300-SSX	Renishaw	(0214)	120.000 in	1	
CBL15	Connectorized Cable	MIL-SPEC Size 16S-7, Cordset, 7 Pole, Male Straight, 5M, 18 awg, 8A, Yellow, PUR	MS16SP-7MPX-5M	MENCOM	(0221)	200.000 in	1	
CBL16	Connectorized Cable	MIL-5015 16S-3A, Male Plug to wire leads	MS16SP-3AMP-5M	MENCOM	(0222)	200.000 in	1	
CBL17	Connectorized Cable	M12-4D Patch Cable	TAD14741111-005	TE Connectivity	(0229)	200.000 in	1	
CBL18	Connectorized Cable	M12-4A Extension Cable	10-04518	Tensility International	(0231)	200.000 in	1	
CBL19	Connectorized Cable	Fortis to M12-8A Encoder Cable	AA-0100-RSX	Renishaw	(0209)	40.000 in	1	
CBL20	Connectorized Cable	Fortis to M12-8A Encoder Cable	AA-0100-RSX	Renishaw	(0210)	40.000 in	1	
CBL21	Connectorized Cable	Fortis to M12-8A Encoder Cable	AA-0100-RSX	Renishaw	(0211)	40.000 in	1	
CBL22	Connectorized Cable	Fortis to M12-8A Encoder Cable	AA-0100-RSX	Renishaw	(0212)	40.000 in	1	
CBL23	Connectorized Cable	Fortis to M12-8A Encoder Cable	AA-0100-RSX	Renishaw	(0213)	40.000 in	1	
CBL24	Connectorized Cable	Fortis to M12-8A Encoder Cable	AA-0100-RSX	Renishaw	(0214)	40.000 in	1	
CBL25	Connectorized Cable	M12-4A Recepticle, Femal Pins, Panel Mount, 2m Long	1446359	Phoenix Contact	(0362)	80.000 in	1	
CBL26	Connectorized Cable	M12-8A Female Recepticle to wire leads (panel mount)	1446391	Phoenix Contact	(0411)	80.000 in	1	

Rev.	Date	Description	Appd. by	Status
A	3/5/2025	Initial Release	A. BURKS	Closed

Project:	NRL 66-5 Upgrade	Designer:	A. Burks
Drawing ID:	NRL-000001-DWG	Reviewer:	J. Sheehan
Sheet Title:	Component List	Sheet #	15 of 17

**BURKS**  
ENGINEERING

info@burksengineering.com

# NRL 66-5 Upgrade (Component List)

Component	Class name	Description	Part number	Manufacturer	Cross Reference	Length	Quantity	Positions
CBL27	Connectorized Cable	M12-8A Female Recepticle to wire leads (panel mount)	1446391	Phoenix Contact	(0431)	80.000 in	1	
CBL28	Connectorized Cable	M12-8A Female Recepticle to wire leads (panel mount)	1446391	Phoenix Contact	(0403)	80.000 in	1	
CBL29	Connectorized Cable	M12-8A Female Recepticle to wire leads (panel mount)	1446391	Phoenix Contact	(0423)	80.000 in	1	
CBL30	Connectorized Cable	M12-8A Female Recepticle to wire leads (panel mount)	1446391	Phoenix Contact	(0451)	80.000 in	1	
CBL31	Connectorized Cable	M12-8A Female Recepticle to wire leads (panel mount)	1446391	Phoenix Contact	(0443)	80.000 in	1	
CBL32	Connectorized Cable	MIL-5015 14S-A7 female recepticle to flying leads (panel mount)	MS14S-7FR-2M-PM	MENCOM	(0500)	80.000 in	1	
CBL33	Connectorized Cable	MIL-5015 14S-A7 female recepticle to flying leads (panel mount)	MS14S-7FR-2M-PM	MENCOM	(0514)	80.000 in	1	
CBL34	Connectorized Cable	MIL-5015 14S-A7 female recepticle to flying leads (panel mount)	MS14S-7FR-2M-PM	MENCOM	(0528)	80.000 in	1	
CBL35	Connectorized Cable	MIL-5015 14S-A7 female recepticle to flying leads (panel mount)	MS14S-7FR-2M-PM	MENCOM	(0540)	80.000 in	1	
CBL36	Connectorized Cable	MIL-5015 14S-A7 female recepticle to flying leads (panel mount)	MS14S-7FR-2M-PM	MENCOM	(0554)	80.000 in	1	
CBL37	Connectorized Cable	MIL-5015 14S-A7 female recepticle to flying leads (panel mount)	MS14S-7FR-2M-PM	MENCOM	(0568)	80.000 in	1	
CBL38	Connectorized Cable	M12-8A Male Plug to wire leads (panel mount)	1446388	Phoenix Contact	(0702)	80.000 in	1	
CBL39	Connectorized Cable	M12-4T Male Plug to wire leads (panel mount)	1420794	Phoenix Contact	(0721)	60.000 in	1	
CBL40	Connectorized Cable	RJ45 to M12-8X (panel mount)	1203410752	Molex	(0804)	80.000 in	1	
CBL41	Connectorized Cable	RJ45 to RJ45 (panel mount)	09454521510	Harting	(0806)	60.000 in	1	
CBL42	Connectorized Cable	Panel Mount USB2.0A Extension Cable	0847290006	Molex	(0804)	80.000 in	1	
CBL43	Connectorized Cable	RJ45 to M12-4D (panel mount)	1204061043	Molex	(0844)	80.000 in	1	
CBL44	Connectorized Cable	RJ45 to M12-4D (panel mount)	1204061043	Molex	(0846)	80.000 in	1	
CN1	Connector	NEMA L5-15R, Panel Mount	ASINL515P	AC Connectors	(0203)		1	
CN2	Connector	MIL-5015 Connector, 14S-A7, Plug, Pins	MS14S-7MP-FW20-SC	MENCOM	(0501)		1	
CN3	Connector	MIL-5015 Connector, 14S-A7, Plug, Pins	MS14S-7MP-FW20-SC	MENCOM	(0515)		1	
CN4	Connector	MIL-5015 Connector, 14S-A7, Plug, Pins	MS14S-7MP-FW20-SC	MENCOM	(0529)		1	
CN5	Connector	MIL-5015 Connector, 14S-A7, Plug, Pins	MS14S-7MP-FW20-SC	MENCOM	(0541)		1	
CN6	Connector	MIL-5015 Connector, 14S-A7, Plug, Pins	MS14S-7MP-FW20-SC	MENCOM	(0555)		1	
CN7	Connector	MIL-5015 Connector, 14S-A7, Plug, Pins	MS14S-7MP-FW20-SC	MENCOM	(0569)		1	
CN8	Connector	M12-8A IDC Field Wireable Connector	1421680	Phoenix Contact	(0705)		1	
CN9	Connector	M12-4T Field Wireable Connector, Plug, Female Pins	1080218	Phoenix Contact	(0722)		1	
EL1	Enclosure Light	Green Light	XB5EVB3	Schneider Electric	(0654)		1	
EL2	Enclosure Light	Red Light	XB5EVB4	Schneider Electric	(0656)		1	
EL3	Enclosure Light	Power Indicator	XB5EVB1	Schneider Electric	(0661)		1	
ENC	Location	Painted Steel Enclosure, 30"x30"x12"	EN4SD30312GY	Hammond			1	
ENC-ACC1	Enclosure accessory	Print Pocket, 12" x 12"	PKT1212	Hammond			1	
ENC-ACC2	Enclosure accessory	Mounting Foot Kit (set of 4)	EZPMFHD	Hammond			1	
ENC-BP	Location	Enclosure Back Panel, Galvanized, for 30"x30"	EPG3030	Hammond	(9-K-7)		1	
ENC-BP-TB1-1-BRIDGE	Terminal block accessory	Plug-In bridge, 5.2mm, 3 Position	3030174	Phoenix Contact	(11-A-1)		1	3
ENC-BP-TB1-CB4	Circuit Breaker	Miniature Circuit Breaker TMC-71C-4A	1019975	Phoenix Contact	(0325)		1	
ENC-BP-TB1-CB5	Circuit Breaker	Miniature Circuit Breaker TMC-71C-4A	1019975	Phoenix Contact	(0344)		1	
ENC-BP-TB1-CB6	Circuit Breaker	Miniature Circuit Breaker TMC-71C-7A	1019978	Phoenix Contact	(0346)		1	
ENC-BP-TB1-CB7	Circuit Breaker	Miniature Circuit Breaker TMC-71C-7A	1019978	Phoenix Contact	(0356)		1	
ENC-BP-TB1-CB8	Circuit Breaker	Miniature Circuit Breaker TMC-71C-4A	1019975	Phoenix Contact	(0361)		1	
ENC-BP-TB1-CB9	Circuit Breaker	Miniature Circuit Breaker TMC-71C-3A	1019974	Phoenix Contact	(0370)		1	
ENC-BP-TB1-CB10	Circuit Breaker	Miniature Circuit Breaker TMC-71C-7A	1019978	Phoenix Contact	(0501)		1	
ENC-BP-TB1-CB11	Circuit Breaker	Miniature Circuit Breaker TMC-71C-7A	1019978	Phoenix Contact	(0515)		1	
ENC-BP-TB1-CB12	Circuit Breaker	Miniature Circuit Breaker TMC-71C-7A	1019978	Phoenix Contact	(0529)		1	

Rev.	Date	Description	Appd. by	Status
A	3/5/2025	Initial Release	A. BURKS	Closed

Project:	NRL 66-5 Upgrade	Designer:	A. Burks
Drawing ID:	NRL-000001-DWG	Reviewer:	J. Sheehan
Sheet Title:	Component List	Sheet #	16 of 17

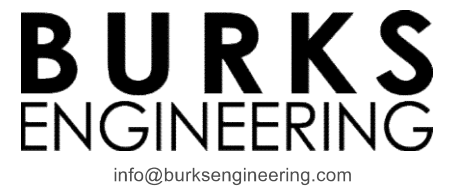

NRL 66-5 Upgrade (Component List)								
Component	Class name	Description	Part number	Manufacturer	Cross Reference	Length	Quantity	Positions
ENC-BP-TB1-CB13	Circuit Breaker	Miniature Circuit Breaker TMC-71C-7A	1019978	Phoenix Contact	(0541)		1	
ENC-BP-TB1-CB14	Circuit Breaker	Miniature Circuit Breaker TMC-71C-7A	1019978	Phoenix Contact	(0555)		1	
ENC-BP-TB1-CB15	Circuit Breaker	Miniature Circuit Breaker TMC-71C-7A	1019978	Phoenix Contact	(0569)		1	
ENC-BP-TB2-13-BRIDGE	Terminal block accessory	Plug-In Bridge, 5.2mm, 10 Position (cut to length)	3030213	Phoenix Contact	(11-F-1)		1	8
ENC-BP-TB2-21 (Stacked)-BRIDGE	Terminal block accessory	Plug-In Bridge, 5.2mm, 5 Position	3030349	Phoenix Contact	(11-F-1)		1	4
ENC-BP-TB2-R1	Relay	RIF-0-RPT-24DC/21 - Relay module	2903370	Phoenix Contact	(0652)		1	
ENC-BP-TB2-R1-BRIDGE	Terminal block accessory	Plug-In Bridge, 5.2mm, 5 Position	3030349	Phoenix Contact	(0652)		1	5
ENC-BP-TB2-R1-BRIDGE	Terminal block accessory	Plug-In Bridge, 5.2mm, 4 Position	3030187	Phoenix Contact	(0652)		1	4
ENC-BP-TB2-R2	Relay	RIF-0-RPT-24DC/21 - Relay module	2903370	Phoenix Contact	(0644)		1	
ENC-BP-TB2-R3	Relay	RIF-0-RPT-24DC/21 - Relay module	2903370	Phoenix Contact	(0646)		1	
ENC-BP-TB2-R4	Relay	RIF-0-RPT-24DC/21 - Relay module	2903370	Phoenix Contact	(0648)		1	
ENC-BP-TB2-R5	Relay	RIF-0-RPT-24DC/21 - Relay module	2903370	Phoenix Contact	(0650)		1	
ENC-BP-TB2-R6	Relay	RIF-0-RPT-24DC/21 - Relay module	2903370	Phoenix Contact	(0604)		1	
ENC-BP-TB3-1-BRIDGE	Terminal block accessory	Plug-In bridge, 5.2mm, 3 Position	3030174	Phoenix Contact	(12-A-1)		1	3
ENC-BP-TB3-CB1	Circuit Breaker	Miniature Circuit Breaker TMC-81C-07A	2907564	Phoenix Contact	(0315)		1	
ENC-BP-TB3-CB2	Circuit Breaker	Miniature Circuit Breaker TMC-81C-12A	2907568	Phoenix Contact	(0335)		1	
ENC-BP-TB3-CB3	Circuit Breaker	Miniature Circuit Breaker TMC-81C-07A	2907564	Phoenix Contact	(0325)		1	
ENC-BP-TB3-PWS1	Power supply	output: 24 V DC, 10 A; input: AC 100...240 V/DC 110...150 V, 1-phase	PS2001-2410-0000	Beckhoff	(0315)		1	
ENC-BP-TB3-PWS2	Power supply	output: 24 V DC, 10 A; input: AC 100...240 V/DC 110...150 V, 1-phase	PS2001-2410-0000	Beckhoff	(0325)		1	
ENC-BP-TB3-PWS3	Power supply	output: 24 V DC, 20 A; input: AC 100...240 V/DC 110...150 V, 1-phase	PS2001-2420-0000	Beckhoff	(0335)		1	
ENC-LEFT-ACC1	Enclosure accessory	Modular Cable Entry Plate, 1x Large, 6x Small	EZ00000001007	Roxtec			1	
ENC-RIGHT-VENT	Enclosure accessory	Exhaust Grille	118710-00	Stego			1	
FAN1	Fan	Intake Filter and Fan	018712-30	Stego	(0370)		1	
LCAMP	Amplifier	Load Cell Amplifier	BX8-HD44-EC	Interface	(0228)		1	
PLC1	PLC	Industrial PC	CX2043-0175	Beckhoff	(0803)		1	
PLC1-AI1	AI Module	2-channel encoder interface, BiSS@ C	EL5042	Beckhoff	(0403)		1	
PLC1-AI2	AI Module	2-channel encoder interface, BiSS@ C	EL5042	Beckhoff	(0423)		1	
PLC1-AI3	AI Module	2-channel encoder interface, BiSS@ C	EL5042	Beckhoff	(0443)		1	
PLC1-AI4	AI Module	4-channel analog input, voltage, ±10 V, 16 bit, differential	EI3104	Beckhoff	(0517)		1	
PLC1-AI5	AI Module	4-channel analog input, voltage, ±10 V, 16 bit, differential	EI3104	Beckhoff	(0557)		1	
PLC1-AO1	AO Module	4-channel analog output, voltage, ±10 V, 16 bit	EL4134	Beckhoff	(0503)		1	
PLC1-AO2	AO Module	4-channel analog output, voltage, ±10 V, 16 bit	EL4134	Beckhoff	(0543)		1	
PLC1-DO1	DO Module	4-channel digital output, 24 V DC, 0.5 A	EL2004	Beckhoff	(0531)		1	
PLC1-DO2	DO Module	4-channel digital output, 24 V DC, 0.5 A	EL2004	Beckhoff	(0571)		1	
PLC1-IO1	PLC Module	2-port EtherCAT junction	EK1122	Beckhoff	(0843)		1	
PLC1-IO2	PLC Module	8-channel digital input + 8-channel digital output	EL1859	Beckhoff	(0603)		1	
PLC1-OPT1	PLC Options	CFast Card	CX2900-0038	Beckhoff	(0803)		1	
PLC1-OPT2	PLC Options	Extension to 16GB Ram	CX2900-0305	Beckhoff	(0803)		1	
PLC1-PM1	Power Module	Power supply unit for CX20xx, 130 W	CX2100-0014	Beckhoff	(0343)		1	
PLC1-PM2	Power Module	Power supply terminal for E-bus, with diagnostics	EL9410	Beckhoff	(0322)		1	
PLC1-PM3	Power Module	Power supply terminal for E-bus, with diagnostics	EL9410	Beckhoff	(0353)		1	
PLC1-SM1	System Module	End Cap	EL9011	Beckhoff			1	
Q1	Disconnect	Rotary Disconnect, Front/Side Mount, 3-Pole, 25A	ML1-025-E-H03R	Merz	(0306)		1	
TS1	Temp. switch	KTS-111 0-60C NO Thermostat	11101.0-00	Stego	(0370)		1	

					Project:	NRL 66-5 Upgrade	Designer:	A. Burks
					Drawing ID:	NRL-000001-DWG	Reviewer:	J. Sheehan
A	3/5/2025	Initial Release	A. BURKS	Closed	Sheet Title:	Component List	Sheet #	17 of 17
Rev.	Date	Description	Appd. by	Status				

